



ACCESSOIRES ELNA

CATALOGUE 2024





BIENVENUE !

Depuis des décennies, la marque **elna** vous offre la qualité, l'innovation et un service après-vente réactif et efficace. Trois des nombreux aspects dont nous tenons à conserver la qualité aujourd'hui.

Pour la marque **elna**, les machines à coudre ne sont pas uniquement un outil technique mais surtout, des partenaires efficaces qui restent à vos côtés pendant un long moment, voire parfois, une vie entière. Même si vos connaissances en couture ne sont plus à prouver, nos machines à coudre vous donneront la possibilité de découvrir des nouveautés.

Notre mission est de vous permettre de développer vos propres talents au travers de ceux de votre machine à coudre **elna**. Pour ce faire, il vous faut utiliser les bons outils, compatibles avec votre modèle elna, et destinés à réaliser la tâche que vous désirez effectuer.

Dans ce catalogue, vous retrouverez ou découvrirez les accessoires optionnels **elna** qui vous aideront à concrétiser vos idées tout en simplifiant les difficultés techniques!

Prenez également le temps de visiter notre site internet www.elna.com dans lequel vous trouverez notamment les instructions sur l'utilisation de nos accessoires standards et optionnels. Enfin, n'oubliez pas que plus vous consacrerez de temps à vous entraîner, plus vos résultats seront réussis et parfaitement exécutés.

Merci d'avoir choisi elna!

Table des matières

Couture, Patchwork et Quilting 5-7mm	pages 4 à 25
Couture, Patchwork et Quilting 9mm	pages 26 à 40
Broderie	pages 41 à 49
Surjeteuses et recouvreuses	pages 50 à 61
Général	pages 62 à 77
Aiguilles standard et optionnels	pages 78 à 82





ACCESSOIRES DE COUTURE, DE PATCHWORK ET DE QUILTING

Pour les machines à coudre avec une largeur de couture de 5 à 7 millimètres

Si vous êtes un amoureux de la couture et un passionné de DIY vous allez adorer découvrir notre vaste collection d'accessoires elna. Vous apprendrez petit à petit comment simplifier des tâches laborieuses et pourrez améliorer vos connaissances, ainsi que vos capacités techniques grâce à nos accessoires. Ces derniers vous aideront certainement à expérimenter de nouvelles techniques, mais dans tous les cas, à finaliser vos projets!



Les modèles de machines à coudre concernés par cette catégorie sont:

Sew Fun, Sew Green, Sew Zebra et Sew 75 (elna 1000)
eXplore 150 et 160
eXplore 220 et 240 (elna 2100, 2110, 2130, 2300)
eXplore 320 et 340 (elna 2600, 2800)
3210 *designed for jeans* (elna 3210, 3230)
elna Star et elna Star Edition
eXperience 450
eXperience 520, 540, 520S, 540S (elna 5100, 5200, 5300)
eXperience 530, 550, 560, 570, 570α
eXcellence 580 et 580+
elna lotus et lotus 2
eXcellence 720 (elna 7200)

N.B. : les anciens modèles correspondants aux modèles de la gamme actuelle sont indiqués entre parenthèses.

Pied patchwork pour couture ¼ de pouce (O)



Ref.:200-318-022



150, 160, 320, 340, 3210j, Star, Lotus/2, 450, 520/S, 530, 540/S, 550, 560, 570/α, 580/+, 720

Pied patchwork pour couture ¼ de pouce (O)



Ref.:200-330-020



Sew, 220, 240

Pied transport supérieur ¼ de pouce – système I.A.F



Ref.:846-423-009



720

Pied transport supérieur ¼ de pouce et plaque aiguille – système I.A.F



Ref.:846-407-041



720

Pied ¼" pour règles à quilter pour les modèles à tige basse



Ref.:202-492-005



elna Star, 450, 520/s, 540/s, Lotus 1, 530, 550, 560, 570/α, 660, 620, 720

Pied à glissière pour boutonnière en 4 étapes



Ref.:200-123-028



Sew, 220, 320

Pied à glissière pour boutonnière en 4 étapes ajustable



Ref.:200-134-022



Sew, 220, 320

Pied pour ourlet invisible ajustable (G)



Ref.:820-817-015



150, 160, 220, 240, 320, 340, 3210j, Star, 450, 520/S, 540/S, 530, 550, 560, 570/α, 580/+, 720

Pied pour ourlet invisible ajustable (L)



Ref.:200-130-028



Sew, 220, 240

Pied pour application (F)

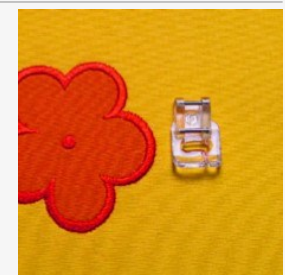

Ref.:202-023-012



150, 160, 320, 340, 3210j, Star, Lotus/2, 450, 520/S, 530, 540/S, 550, 560, 570/α, 580/+, 720

Pied boutonnière automatique (R)



Ref.:753-801-004



340, 3210Jeans, Star, Lotus/2, 520/S, 540/S, 520, 540, 620, 660, 720, 740, 580, 580+,

Pied pour pose de perles et de mèches de 2 et 4 mm

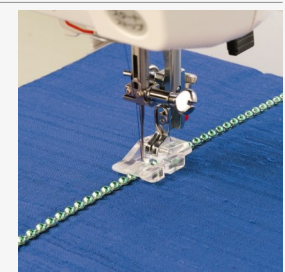

Ref.:200-321-028



150, 160, 320, 340, 3210j, Star, Lotus/2, 450, 520/S, 530, 540/S, 550, 560, 570/α, 580/+, 720

Pied pour pose de biais - pied à border

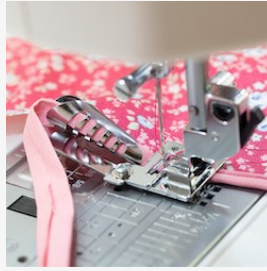

Ref.:200-140-021



Sew, 220, 240

Pied pour pose de biais - pied à border

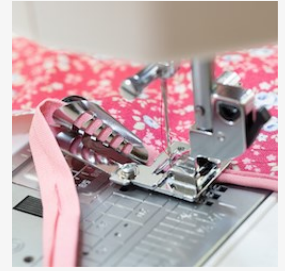

Ref.:200-313-027



150, 160, 320, 340, 3210j, Star, Lotus/2, 450, 520/S, 530, 540/S, 550, 560, 570/a, 580, 580+, 720

Pied pour ourlet invisible avec guide médian fixe (G)



Ref.:395-719-48



150, 160, 220, 240, 320, 340, 3210j, Star, Lotus/2, 450, 520/S, 540/S, 530, 550, 560, 570/α, 580/+, 720

Pied soutache



Ref.:494-660-15



Sew, 220, 240

Pied pour pose de bouton (T)



Ref.:200-131-029



Sew, 220, 240

Pied pour pose de bouton (T)



Ref.:200-136-024



320, 340, 3210j, Star, Lotus/2, 450, 520/S, 540/S, 530, 550, 560, 570/α, 580/+, 720

Pied zigzag transparent avec protection doigts



Ref.:749-522-005

 150, 160, 320, 340, 3210j, Lotus/2, 450, 520/S, 540/S, 530, 550, 560, 570/α, 580+

Pied avec guide central



Ref.:200-341-024

 150, 160, 320, 340, 3210j, Star, Lotus/2, 450, 520/S, 530, 540/S, 550, 560, 570/α, 580/+, 720

Pied transport supérieur avec guide central – système I.A.F



Ref.:846-413-062

 720

Pied pour couture en bordure



Ref.:202-252-001

 150, 160, 320, 340, 3210j, Star, Lotus/2, 450, 520/S, 530, 540/S, 550, 560, 570/α, 580/+, 720

Pied quilting en piqué libre



Ref.:200-127-022

 Sew, 220, 240

Pied quilting en piqué libre



Ref.:200-325-022

 580/+, 720

Pied quilting en piqué libre



Ref.:200-349-022



150, 160, 320, 340, 3210j, Star, Lotus/2, 450, 520/S, 540/S, 530, 550, 560, 570/α

Unité pour double transport avec guide de matelassage



Ref.:200-309-019



580/+

Unité pour double transport avec guide de matelassage



Ref.:200-310-013



Sew, 220, 240

Unité pour double transport avec guide de matelassage



Ref.:200-311-014



150, 160, 320, 340, 3210j, Star, Lotus/2, 450, 520/S, 540/S, 530, 550, 560, 570/α

Pied pour double transport à fourche ouverte



Ref.:200-048-109



530, 550, 560, 570/α

Unité pour double transport avec pied à fourche ouverte et guide de matelassage



Ref.:200-338-028



580/+

Unité pour double transport avec pied à fourche ouverte et guide de matelassage



Ref.:200-339-029



150, 160, 320, 340, 3210j, Star, Lotus/2, 450, 520/S, 540/S, 530, 550, 560, 570/α

Pied pour fleurs et cercles



Ref.:202-258-007



150, 160, 220, 240, 320, 340, 3210j, Star, Lotus/2, 450, 520/S, 540/S, 530, 550, 560, 570/α, 720

Pied quilting pour broderie à fil couché (FMC)



Ref.:202-142-007



580/+

Pied pour quilting en piqué libre

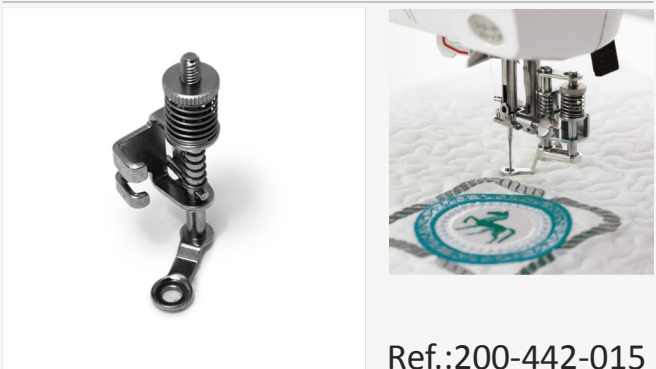

Ref.:200-442-015



580/+, 720

Pied pour boucles ou franges



Ref.:200-050-104



580/+, 720

Pied pour boucles ou franges



Ref.:200-051-105



Star, Lotus/2, 450, 520/S, 540/S, 530, 550, 560, 570/α

Pied pour boucles ou franges



Ref.:200-101-008



Sew, 150, 160, 220, 240, 320, 340, 3210j

Pied à froncer (V)

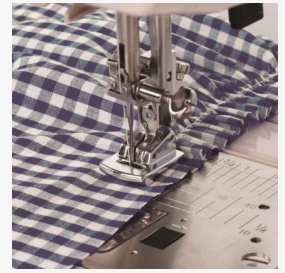
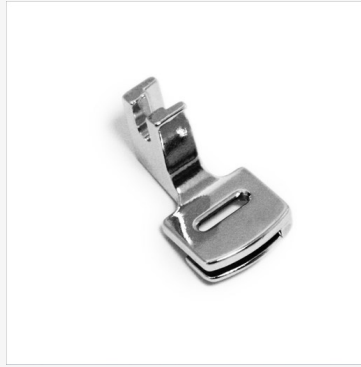

Ref.:200-124-029



Sew, 220, 240

Pied à froncer (V)

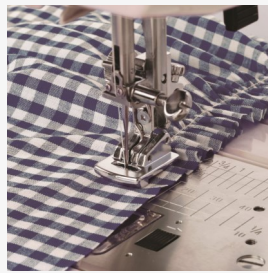

Ref.:200-315-029



150, 160, 320, 340, 3210j, Star, Lotus/2, 450, 520/S, 530, 540/S, 550, 560, 570/α, 580/+, 720

Pied pour pose de fermeture éclair invisible

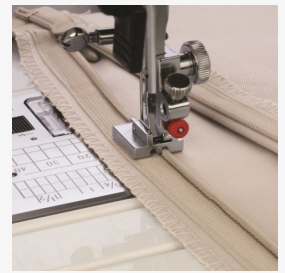

Ref.:200-333-023



150, 160, 320, 340, 3210j, Star, Lotus/2, 450, 520/S, 530, 540/S, 550, 560, 570/α, 580/+, 720

Pied pour pose de fermeture éclair invisible



Ref.:202-499-002



Sew, 220, 240

Pied pour pose de cordonnets (H)

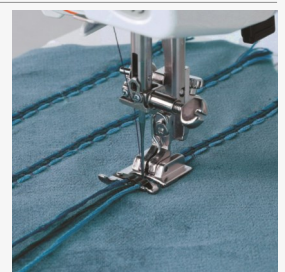
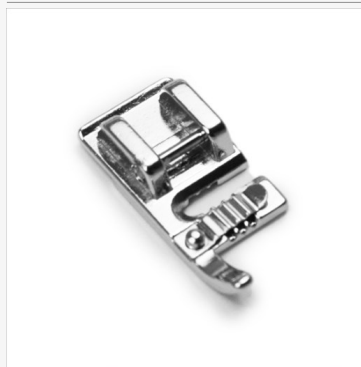

Ref.:200-126-021



Sew, 220, 240

Pied pour pose de cordonnets (H)

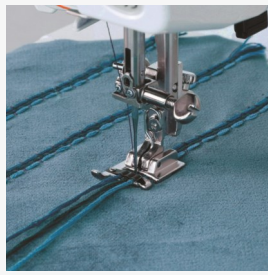

Ref.:200-345-028



150, 160, 320, 340, 3210j, Star, Lotus/2, 450, 520/S, 530, 540/S, 550, 560, 570/α, 580/+, 720

Pied à broder et à repriser à fourche ouverte



Ref.:200-340-023



150, 160, 320, 340, 3210j, Star, Lotus/2, 450, 520/S, 540/S, 530, 550, 560, 570/α

Pied à border et à repriser à fourche ouverte PD-H

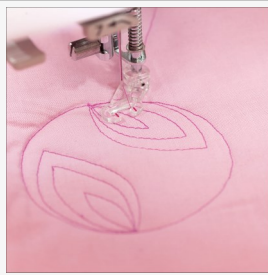

Ref.:200-337-027



580/+, 720

Pied transport supérieur à fourche ouverte - système I.A.F

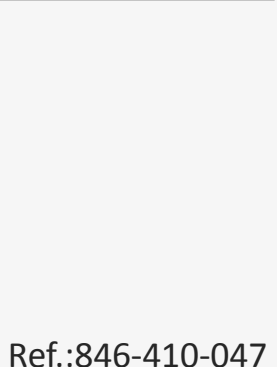
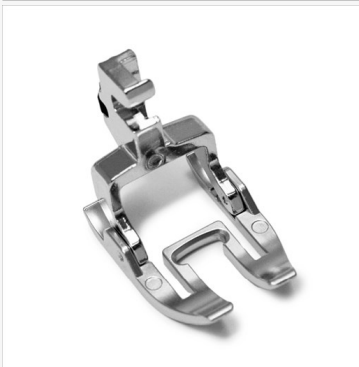

Ref.:846-410-047



720

Pied overlock (M)

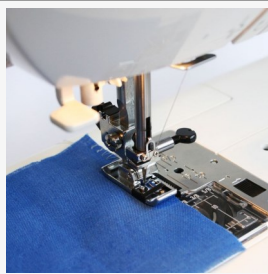

Ref.:822-808-008



320, 340, 3210j, Star, Lotus/2, 520/S, 530, 550, 560, 570/α, 580/+, 720

Pied pour surfilage (C)



Ref.:822-801-001



320, 340, 3210j, Star, Lotus/2, 450, 540/S, 530, 550, 560, 570/α, 580/+, 720

Pied pour surfilage (G)

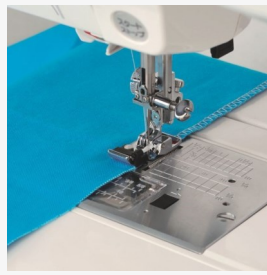

Ref.:200-132-020



Sew, 220, 240

Pied pour boutonnière extra-longue ou difficile d'accès



Ref.:820-801-016



320, 340, 3210j, Star, Lotus/2, 450, 520/S, 540/S, 530, 550, 560, 570/α, 580/+

Pied pour nervures étroites avec aiguille jumelée



Ref.:200-328-025



Sew, 220, 240

Pied pour passepoil

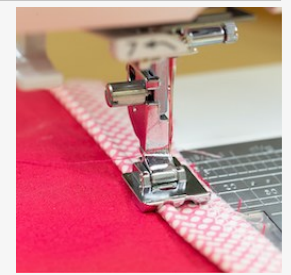

Ref.:200-314-028



150, 160, 320, 340, 3210j, Star, Lotus/2, 450, 520/S, 530, 540/S, 550, 560, 570/α, 580/+, 720

Pied pour pose de paillettes et de rubans



Ref.:200-332-022



150, 160, 320, 340, 3210j, Star, Lotus/2, 450, 520/S, 530, 540/S, 550, 560, 570/α, 580/+, 720

Pieds pour ourlet roulé : set de 2 pieds (4mm et 6mm)

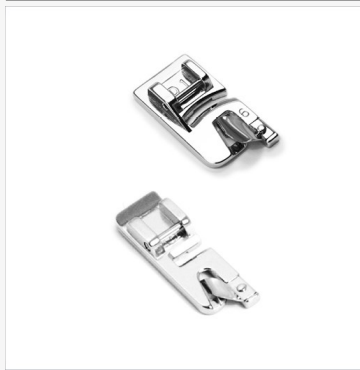

Ref.:200-326-023



150, 160, 320, 340, 3210j, Star, Lotus/2, 450, 520/S, 530, 540/S, 550, 560, 570/α, 580/+, 720

Pied pour ourlet roulé (D)



Ref.:202-251-000

 Sew, 220, 240

Pied pour ourlet roulé 3mm (D)



Ref.:820-809-014

 150, 160, 3210j, Lotus/2, 450, 520/S, 540/S, 530, 550, 560, 570/α, 580+

Pied à rouleau pour cuir et daim

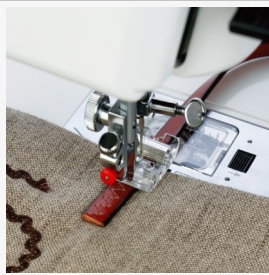

Ref.:200-142-023

 Sew, 220, 240

Pied à rouleau pour cuir et daim

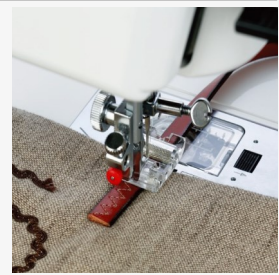

Ref.:200-316-020

 150, 160, 320, 340, 3210j, Star, Lotus/2, 450, 520/S, 530, 540/S, 550, 560, 570/α, 580/+, 720

Pied à rouleaux HD

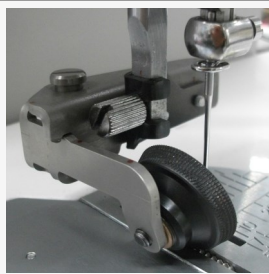

Ref.:202-420-002

 580/+

Appareil à plisser



Ref.:943-100-000

 150, 160, 220, 240, 320, 340, 3210j, Star, Lotus/2, 450, 520/S, 530, 540/S, 550, 560, 570/α, 580/+,

Appareil à plisser encliquetable

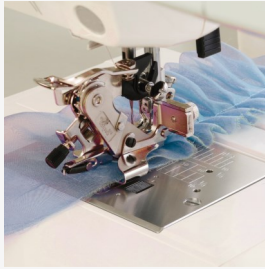

Ref.:846-415-031



150, 160, 320, 340, 3210j, Star, Lotus/2, 450, 520/S, 530, 540/S, 550, 560, 570/α, 580/+, 720

Appareil à plisser vissable
(fixation à la barre aiguille)



Ref.:941-620-305



Sew, 220, 240

Appareil à plisser vissable
(fixation à la barre aiguille)



Ref.:941-623-000A



150, 160, 220, 240, 320, 340, 3210j, Lotus/2, 450, 520/S, 540/S, 530, 550, 560, 570/α

Pied pour point satin avec guides intégrés

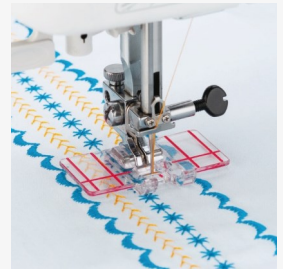
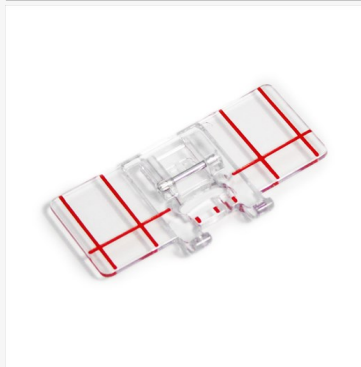

Ref.:200-434-025



150, 160, 320, 340, 3210j, Star, Lotus/2, 450, 520/S, 530, 540/S, 550, 560, 570/α, 580/+, 720

Pied satin multifonctions (F)



Ref.:200-129-024



Sew, 220, 240

Pied satin (F)

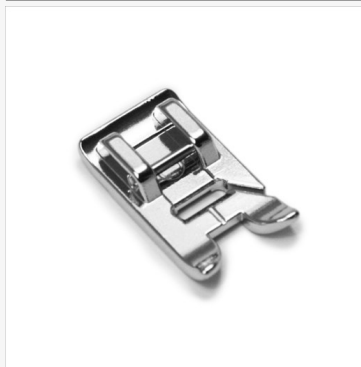

Ref.:822-804-118



320, 340, 3210Jeans, Star, Lotus/2, 450, 520/S, 540/S, 520, 540, 530, 550, 560, 570, 570/α, 620, 660, 720, 740, 580, 580+

Pied multifonctions à fourche ouverte



Ref.:200-137-025



150, 160, 320, 340, 3210j, Star, Lotus/2, 450, 520/S, 530, 540/S, 550, 560, 570/α, 580/+, 720

Pied avec guide de couture ajustable intégré



Ref.:202-221-001



320, 340, 3210j, Star, Lotus/2, 450, 520/S, 530, 540/S, 550, 560, 570/α, 580/+, 720

Pied standard en métal (A)



Ref.:611-511-001



Sew, 150, 160, 220, 240

Pied standard en métal (A)

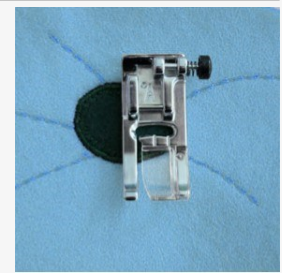
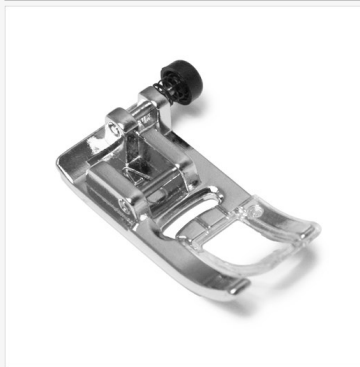

Ref.:825-510-032



320, 340, 3210j, Star, Lotus/2, 450, 520/S, 540/S, 530, 550, 560, 570/α, 580/+, 720

Pied pour couture droite



Ref.:200-125-020



Sew, 220, 240

Pied pour couture droite

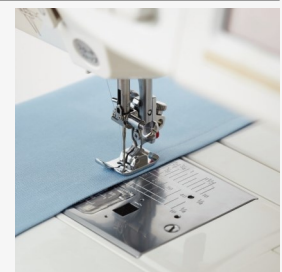

Ref.:200-331-021



150, 160, 320, 340, 3210j, Star, Lotus/2, 450, 520/S, 530, 540/S, 550, 560, 570/α, 580/+, 720

Pied pour guide pour biais (TG)

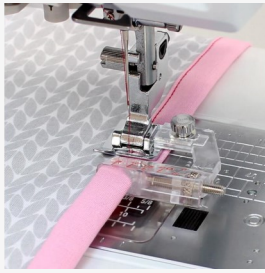

Ref.:202-392-004



150, 160, 320, 340, 3210j, Lotus/2, 450, 520/S, 540/S, 530, 550, 560, 570/α, 580+

Pied jersey



Ref.:202-509-006



Sew, 220, 240

Pied ultra glisse anti-adhérent

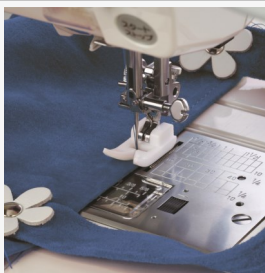

Ref.:200-141-022



Sew, 220, 240

Pied ultra glisse anti-adhérent

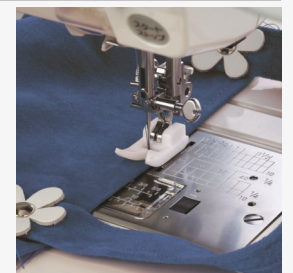

Ref.:200-329-026



150, 160, 220, 240, 320, 340, 3210j, Star, Lotus/2, 450, 520/S, 540/S, 530, 550, 560, 570/α, 580/+, 720

Pied pour pose de fermeture éclair (E)

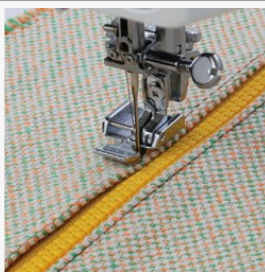

Ref.:808-852-003



320, 340, 3210Jeans, Star, Lotus/2, 450, 520/S, 540/S, 520, 540, 530, 550, 560, 570, 570/α, 620, 660, 720, 740, 580, 580+

Pied étroit pour pose de fermeture éclair



Ref.:200-334-024



580/+, 740

Pied étroit pour pose de fermeture éclair



Ref.:200-342-025



Sew, 150, 160, 220, 240, 320, 340, 3210j, Star, Lotus/2, 450, 520/S, 540/S, 530, 550, 560, 570/α

Pied transparent de quilting avec deux guides

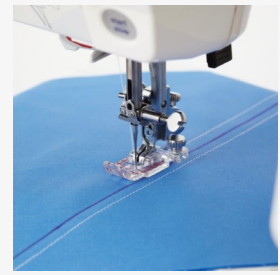

Ref.:200-449-012



150, 160, 320, 340, 3210j, Star, Lotus/2, 450, 520/S, 530, 540/S, 550, 560, 570/α, 580/+, 720

Kit complet avec unité pour double transport



Ref.:214-516-014



580/+

Kit complet avec unité pour double transport

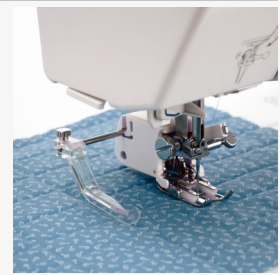

Ref.:214-517-015



150, 160, 320, 340, 3210j, Star, Lotus/2, 450, 520/S, 540/S, 530, 550, 560, 570/α

Kit complet de pieds pour le quilting en piqué libre

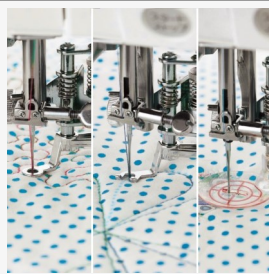

Ref.:202-001-014



580/+, 720

Kit complet de pieds pour le quilting en piqué libre

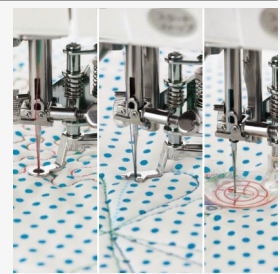

Ref.:202-002-015



150, 160, 3210j, Star, Lotus/2, 450, 520/S, 540/S, 530, 550, 560, 570/α

Kit de pieds pour le quilting en piqué libre



Ref.:767-434-016



150, 160, Star, Lotus/2, 520/S, 530, 540/S, 550, 560, 570/α, 580/+, 720
Qu'en supplément pour le kit 202-002-015 / 202-001-014

Pieds pour nervures avec aiguille jumelée - large et étroit

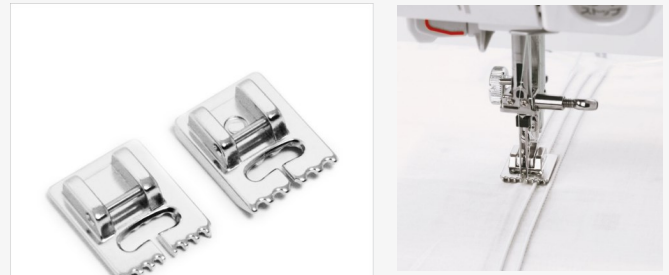

Ref.:200-317-021



150, 160, 320, 340, 3210j, Star, Lotus/2, 450, 520/S, 530, 540/S, 550, 560, 570/α, 580/+, 720

Plaque stabilisatrice pour pied boutonnière automatique (R)



Ref.:202-030-001



240, 340, 3210j, Star, Lotus/2, 520/S, 540/S, 530, 550, 560, 570/α, 580/+, 720
For 7mm models use plate holder 200-428-406

Guide tissu T

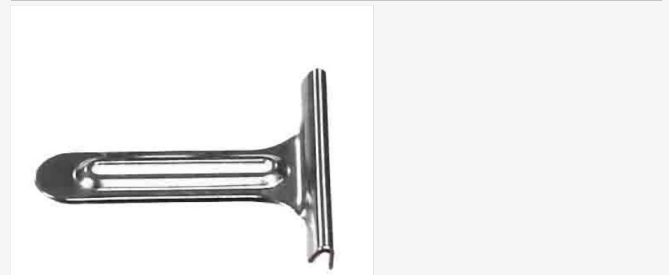

Ref.:200-100-100



150, 160, 220, 240, 320, 340, 3210j, 450, 520/S, 540/S, 530, 550, 560, 570/α, Lotus/2, 580/+

Guide étroit pour nervures renforcées par la pose de cordonnets



Ref.:503-810-005



150, 160, 3210j, 450, Lotus/2

Guide large pour nervures renforcées par la pose de cordonnets



Ref.:503-809-001



150, 160, 3210j, 450, Lotus/2

Dispositif et pied pour pose de biais

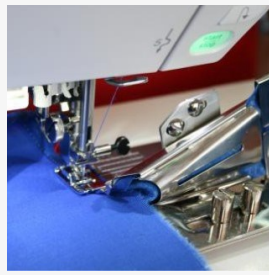

Ref.:202-250-009



Lotus/2, 580/+, 720

Guide de matelassage



Ref.:802-422-002



150, 160, 320, 340, 3210j, Star, Lotus/2, 450, 520/S, 530, 540/S, 550, 560, 570/α, 580/+

Guide de couture sur rubans - large



Ref.:200-444-419



150, 160, 320, 340, Star, Lotus/2, 450, 520/S, 540/S, 530, 550, 560, 570/α, 580/+

Longs guides de matelassage



Ref.:202-025-405



150, 160, 320, 340, 3210j, Star, Lotus/2, 450, 520/S, 530, 540/S, 550, 560, 570/α, 580/+

Guides pour nervures renforcées par la pose de cordonnets - large et étroit



Ref.:200-324-021



320, 340, Star, 520/S, 540/S

Guides pour nervures renforcées par la pose de cordonnets - large et étroit



Ref.:202-238-001



530, 550, 560, 570/α, 580/+

Guide de matelassage et guide pour couture centrale



Ref.:202-249-005



150, 160, 220, 240, 320, 340, 3210j, Star, Lotus/2, 450, 520/S, 530, 540/S, 550, 560, 570/α, 580/+

Plaque aiguille pour couture droite

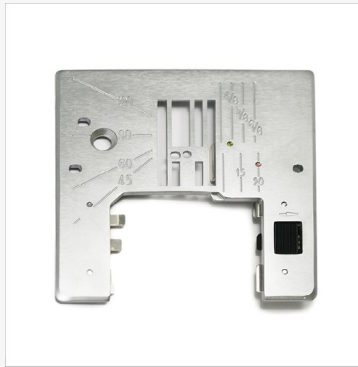

Ref.:200-088-101



520/S, 540/S

Plaque aiguille pour couture droite



Ref.:503-821-009



3210j

Plaque aiguille pour couture droite

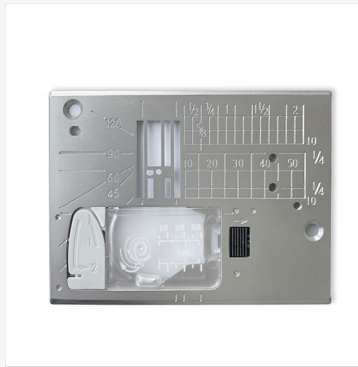

Ref.:809-833-012



530, 550, 560, 570/α, Lotus/2, 580+

Plaque aiguille pour couture droite



Ref.:846-833-109



720

Guide pour couture circulaire

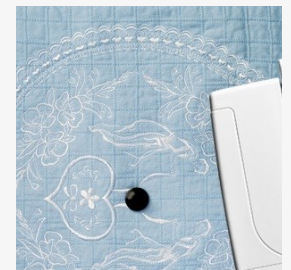

Ref.:202-106-009



3210j, 720

Guide pour couture circulaire

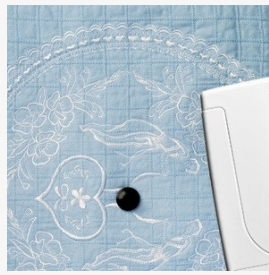

Ref.:202-107-000



320, 340, Star, 520/S, 540/S

Guide pour couture circulaire



Ref.:202-242-008



530, 550, 560, 570/α, 580/+

Capsule spéciale pour gros fil ou fil à broder

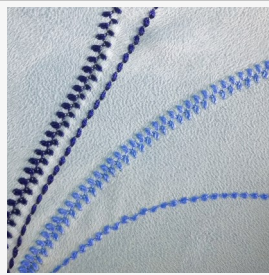

Ref.:200-056-007



320, 340, 3210j, Star, 450, 520/S, 540/S

Capsule spéciale pour quilting en piqué libre

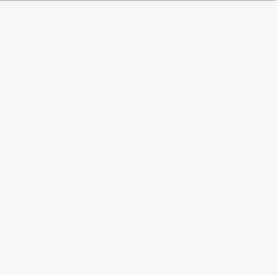
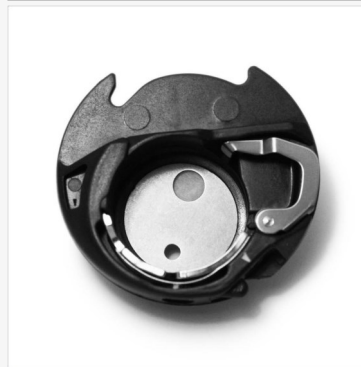

Ref.:200-445-029



530, 550, 560, 570/α, Lotus/2, 580/+

Capsule spéciale pour quilting en piqué libre

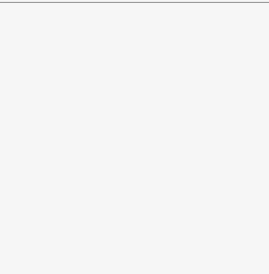

Ref.:202-006-019



150, 160, 320, 340, 3210j, Star, 450, 520/S, 540/S

Guide fronçeur pour élastique 10 mm de largeur

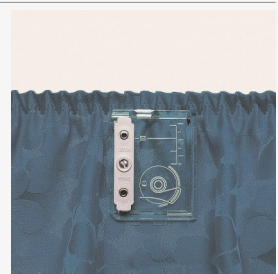
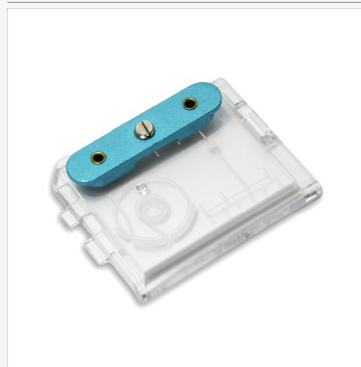

Ref.:495-845-20



320, 340, Star, 520/S, 540/S

Guide fronceur pour élastique
10 mm de largeur

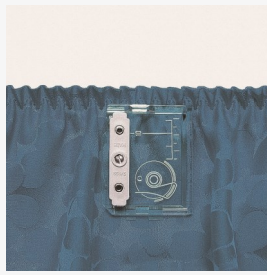

Ref.:495-846-20



3210j, 450, Lotus/2, 720

Guide fronceur pour élastique
13 mm de largeur



Ref.:495-525-20



320, 340, Star, 520/S, 540/S

Guide fronceur pour élastique
13 mm de largeur

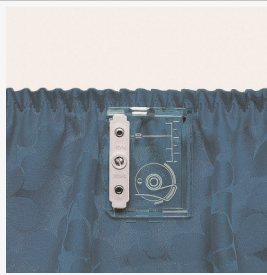

Ref.:495-526-20



3210j, 450, Lotus/2, 720

Guide fronceur pour élastique
8 mm de largeur



Ref.:495-390-20



320, 340, Star, 520/S, 540/S

Guide fronceur pour élastique
8 mm de largeur

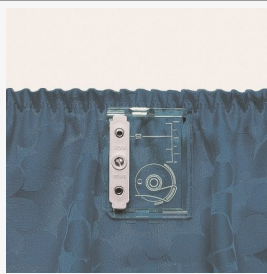

Ref.:495-395-20



150, 160, 3210j, 450, Lotus/2, 720

Plaquette faux-jour étroite pour espace
de 2.5 mm



Ref.:395-731-58



3210j, 450, Lotus/2, 720

Plaquette faux-jour étroite pour espace de 2.5 mm



Ref.:495-560-20



320, 340, Star, 520/S, 540/S

Plaquette faux-jour étroite pour espace de 5 mm



Ref.:395-731-59



3210j, Lotus/2, 720

Loupe optique ajustable (1.2x)



Ref.:202-399-001



530, 550, 560, 570/α, 580/+

Set de trois loupes optiques 1.2x, 1.4x and 1.6x.



Ref.:202-157-005



530, 550, 560, 570/α, 580/+



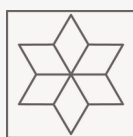

ACCESSOIRES DE COUTURE, DE PATCHWORK ET DE QUILTING

Pour les machines à coudre avec une largeur
de couture de 9 millimètres

Voici la collection d'accessoires dédiés à la couture qui ont été conçus spécialement pour nos modèles de machines à coudre informatisées haut de gamme. Ces modèles puissants offrent de multiples fonctions supérieures, un espace de travail extra-large pour un confort de couture ultime. Grâce aux accessoires compatibles avec votre modèle, vous pourrez non seulement décupler vos possibilités mais aussi gagner du temps en simplifiant des procédés techniques ardues.



Les modèles de machines à coudre concernés par cette catégorie sont:

eXcellence 680 et 680+
eXcellence 710
eXcellence 720PRO
eXcellence 730 et 730PRO
eXcellence 760 et 760PRO
eXcellence 770
eXcellence 782
eXcellence 780 et 780+
eXcellence 790PRO et 792PRO

Appareil à plisser

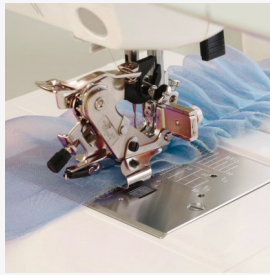

Ref.: 202-095-200

 680/+, 710, 720PRO, 730/PRO, 760/PRO, 770, 780/+, 782, 790PRO, 792PRO, 850, 860, 900, 920

Pied ¼" pour règles à quilter pour les modèles 9 mm/7 mm à tige haute



Ref.: 202-493-006

 580/+, 680/+, 710, 720PRO, 740, 730/PRO, 760/PRO, 770, 780/+, 782, 790PRO, 792PRO, 900, 920

Pied à 9 trous pour pose de cordonnets H2



Ref.: 202-507-004

 782, 792PRO

Pied à broder et à reprendre à fourche ouverte PD-H

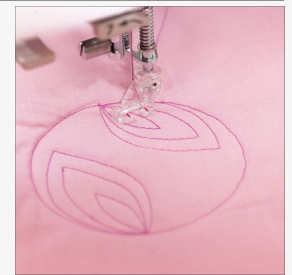

Ref.: 859-839-013

 680/+, 710, 720PRO, 770, 780/+, 850, 860, 920

Pied à double entrainement étroit Dual Feed Plus avec support (VD)

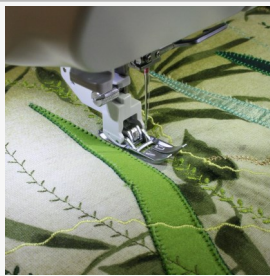

Ref.: 202-257-006

 710, 720PRO, 730/PRO, 760/PRO, 770, 780/+, 782, 790PRO, 792PRO, 900, 920

Pied à double entrainement étroit Dual Feed Plus pour fermeture éclair (ED)

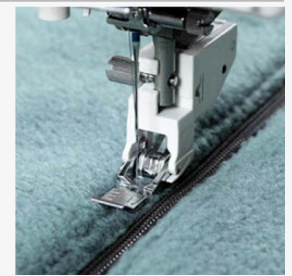

Ref.: 202-155-003

 710, 720PRO, 730/PRO, 760/PRO, 770, 780/+, 782, 790PRO, 792PRO, 900, 920

Pied à double entraînement large Dual Feed (AD)



Ref.: 859-819-017



720PRO, 730/PRO, 760/PRO, 770, 780/+, 920

Pied à double entraînement large Dual Feed ¼ de pouce (OD)



Ref.: 202-235-008



710, 720PRO, 730/PRO, 760/PRO, 770, 780/+, 782, 790PRO, 792PRO, 900, 920

Pied à double entraînement large Dual Feed à fourche ouverte (UD)



Ref.: 202-236-009



710, 720PRO, 730/PRO, 760/PRO, 770, 780/+, 782, 790PRO, 792PRO, 900, 920

Pied à double entraînement large Dual Feed avec guide central (SD)

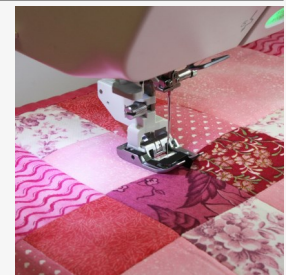

Ref.: 202-103-202



710, 720PRO, 730/PRO, 760/PRO, 770, 780/+, 782, 790PRO, 792PRO, 900, 920

Pied à double entraînement large Dual Feed pour point droit (STD)



Ref.: 202-102-201



710, 720PRO, 730/PRO, 760/PRO, 770, 780/+, 782, 790PRO, 792PRO, 900, 920

Pied à double niveau



Ref.: 202-488-008



680/+, 710, 720PRO, 730/PRO, 760/PRO, 770, 780/+, 782, 790PRO, 792PRO, 850, 860, 900, 920

Pied à froncer (V)

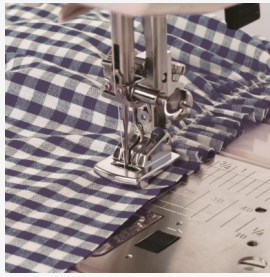

Ref.: 202-096-201



680/+, 710, 720PRO, 730/PRO, 760/PRO, 770, 780/+, 782, 790PRO, 792PRO, 850, 860, 900, 920

Pied à rouleaux HD



Ref.: 202-420-002



680/+, 720PRO, 730/PRO, 760/PRO, 770, 780/+, 782, 790PRO, 792PRO, 850, 860, 920

Pied avec guide central (S)



Ref.: 202-087-209



680/+, 710, 720PRO, 730/PRO, 760/PRO, 770, 780/+, 782, 790PRO, 792PRO, 850, 860, 900, 920

Pied avec guide de couture ajustable intégré



Ref.: 202-294-005



680/+, 710, 720PRO, 730/PRO, 760/PRO, 770, 780/+, 790PRO, 792PRO, 850, 860, 920

Pied boutonnière large avec plaque stabilisatrice

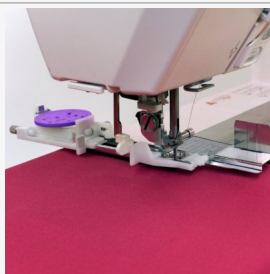

Ref.: 202-312-000



680/+, 710, 720PRO, 730/PRO, 760/PRO, 770, 780/+, 790PRO, 792PRO, 850, 860, 920

Pied de recouvrement

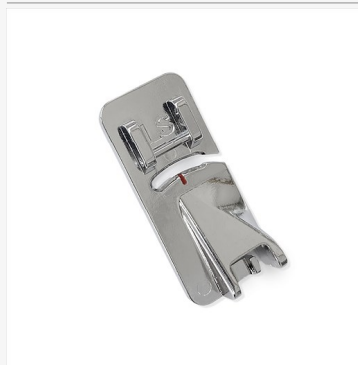

Ref.: 202-490-003



680/+, 710, 720PRO, 730/PRO, 760/PRO, 770, 780/+, 782, 790PRO, 792PRO, 850, 860, 900, 920

Pied étroit pour pose de fermeture éclair



Ref.: 200-334-024



680/+, 720PRO, 730/PRO, 760/PRO, 770, 780/+, 782, 850, 860, 900, 920

Pied patchwork pour couture ¼ de pouce (O)



Ref.: 859-814-012



680/+, 720PRO, 730/PRO, 760/PRO, 770, 780/+, 850, 860, 920

Pied patchwork pour couture ¼ de pouce sans guide (O)

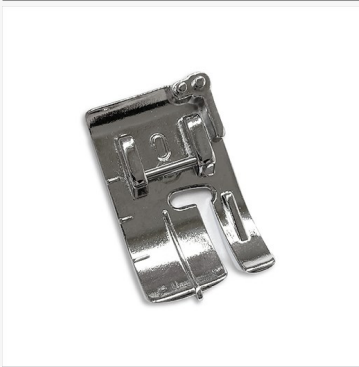

Ref.: 202-313-104



680/+, 710, 720PRO, 730/PRO, 760/PRO, 770, 780/+, 850, 860, 900, 920

Pied pour application (AP)



Ref.: 202-086-208



680/+, 710, 720PRO, 730/PRO, 760/PRO, 770, 780/+, 782, 790PRO, 792PRO, 850, 860, 900, 920

Pied pour boutonnière extra-longue ou difficile d'accès (B)



Ref.: 202-082-204



680/+, 710, 720PRO, 730/PRO, 760/PRO, 770, 780/+, 782, 790PRO, 792PRO, 850, 860, 900, 920

Pied pour couture droite (ST)



Ref.: 202-083-205



680/+, 710, 720PRO, 730/PRO, 760/PRO, 770, 780/+, 782, 790PRO, 792PRO, 850, 860, 900, 920

Pied pour couture en bordure (SE)



Ref.: 202-100-209

680/+, 710, 720PRO, 730/PRO, 760/PRO, 770, 780/+, 782, 790PRO, 792PRO, 850, 860, 900, 920

Pied pour guide pour biais (TG)

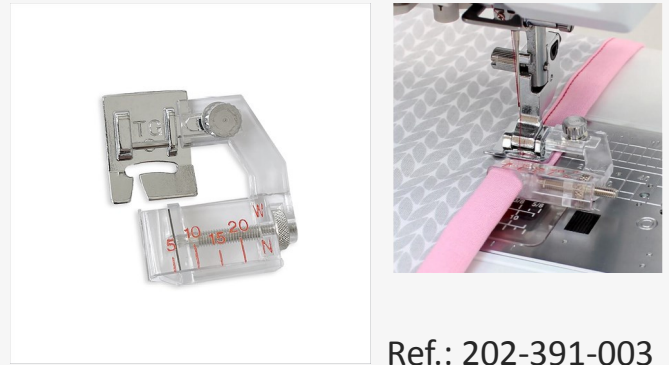

Ref.: 202-391-003

680/+, 720PRO, 730/PRO, 760/PRO, 770, 780/+, 782, 792PRO, 850, 860, 900, 920

Pied pour nervures étroites avec aiguille jumelée (N2)



Ref.: 202-094-209

680/+, 710, 720PRO, 730/PRO, 760/PRO, 770, 780/+, 782, 790PRO, 792PRO, 850, 860, 900, 920

Pied pour nervures larges avec aiguille jumelée (N1)



Ref.: 202-093-208

680/+, 710, 720PRO, 730/PRO, 760/PRO, 770, 780/+, 782, 790PRO, 792PRO, 850, 860, 900, 920

Pied pour ourlet roulé 4 mm de largeur (D2)

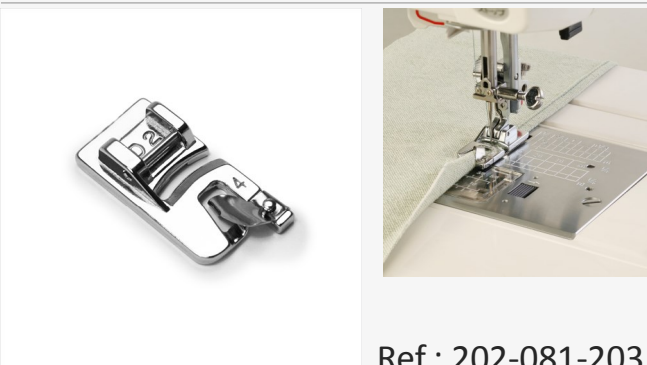

Ref.: 202-081-203

680/+, 710, 720PRO, 730/PRO, 760/PRO, 770, 780/+, 782, 790PRO, 792PRO, 850, 860, 900, 920

Pied pour ourlet roulé 6 mm de largeur (D1)

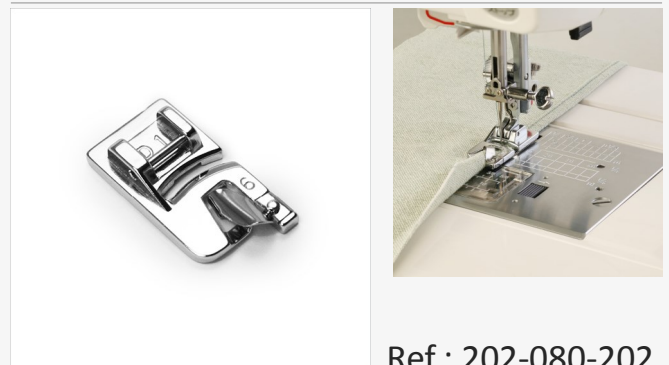

Ref.: 202-080-202

680/+, 710, 720PRO, 730/PRO, 760/PRO, 770, 780/+, 782, 790PRO, 792PRO, 850, 860, 900, 920

Pied pour passepoil (étroit)
Largeur max. de la mèche 3 mm



Ref.: 202-489-009

 680/+, 710, 720PRO, 730/PRO, 760/PRO, 770, 780/+, 782, 790PRO, 792PRO, 850, 860, 900, 920

Pied pour passepoil (l)
Largeur max. de la mèche 5 mm



Ref.: 202-088-200

 680/+, 710, 720PRO, 730/PRO, 760/PRO, 770, 780/+, 782, 790PRO, 792PRO, 850, 860, 900, 920

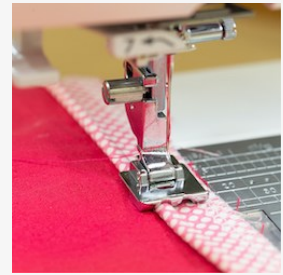

Pied pour point satin avec guides intégrés (FB)



Ref.: 202-084-206

 680/+, 710, 720PRO, 730/PRO, 760/PRO, 770, 780/+, 782, 790PRO, 792PRO, 850, 860, 900, 920

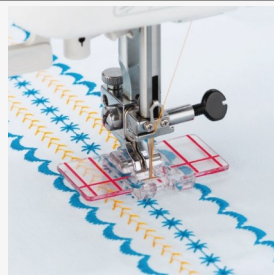

Pied pour pose de biais - pied à border (W)



Ref.: 202-099-204

 680/+, 710, 720PRO, 730/PRO, 760/PRO, 770, 780/+, 782, 790PRO, 792PRO, 850, 860, 900, 920

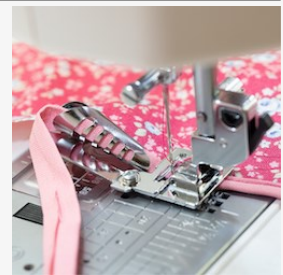

Pied pour pose de cordonnets (H)



Ref.: 202-085-207

 680/+, 710, 720PRO, 730/PRO, 760/PRO, 770, 780/+, 782, 790PRO, 792PRO, 850, 860, 900, 920

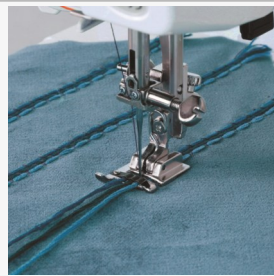

Pied pour pose de fermeture éclair invisible (Z)



Ref.: 202-156-004

 680/+, 710, 720PRO, 730/PRO, 760/PRO, 770, 780/+, 850, 860, 900, 920

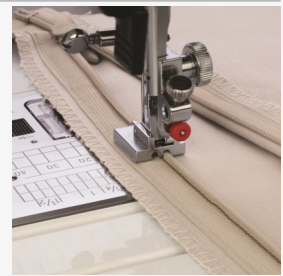

Pied pour pose de paillettes et de rubans (RS)



Ref.: 202-090-205



680/+, 710, 720PRO, 730/PRO, 760/PRO, 770, 780/+, 782, 790PRO, 792PRO, 850, 860, 900, 920

Pied pour pose de perles et de mèches de 2.5 à 4 mm (L2)

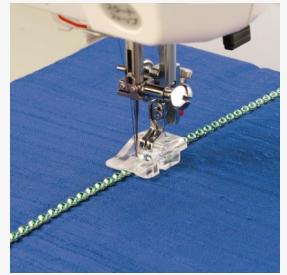

Ref.: 202-098-203



680/+, 710, 720PRO, 730/PRO, 760/PRO, 770, 780/+, 782, 790PRO, 792PRO, 850, 860, 900, 920

Pied pour pose de perles et de mèches jusqu'à 2 mm de diamètre (L1)

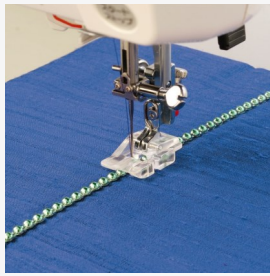

Ref.: 202-097-202



680/+, 710, 720PRO, 730/PRO, 760/PRO, 770, 780/+, 782, 790PRO, 792PRO, 850, 860, 900, 920

Pied pour règles à quilter avec support QB-S



Ref.: 858-820-029



770, 780

Pied professionnel ¼ de pouce HP



Ref.: 865-803-006



770

Pied professionnel à double entraînement étroit Dual Feed Plus (HP2)



Ref.: 202-416-005



720PRO, 770, 780/+, 920



Pied quilting en piqué libre à fourche fermée (QC)



Ref.: 859-836-009



770, 780/+, 920

Pied quilting en piqué libre à fourche ouverte (QO)

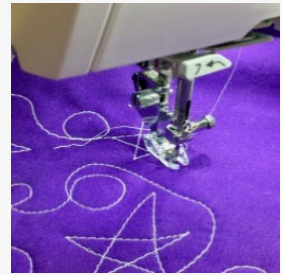

Ref.: 859-837-000



770, 780/+, 920

Pied quilting pour broderie à fil couché (FMC)



Ref.: 202-142-007



680/+, 710, 720PRO, 730/PRO, 760/PRO, 770, 780/+, 782, 790PRO, 792PRO, 850, 860, 900, 920

Pied satin à fourche ouverte (F2)

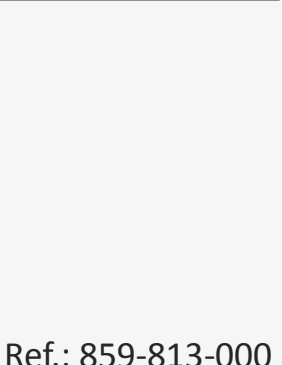

Ref.: 859-813-000



680/+, 720PRO, 770, 780/+, 850, 860, 920

Pied transparent ¼ de pouce pour points droits (OM)

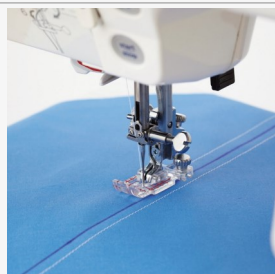

Ref.: 202-239-002



680/+, 710, 720PRO, 730/PRO, 760/PRO, 770, 780/+, 782, 790PRO, 792PRO, 850, 860, 900, 920

Pied transparent pour quilting en piqué libre (QV)



Ref.: 859-812-009



770, 780/+, 920

Pied ultra glisse anti-adhérent (U)

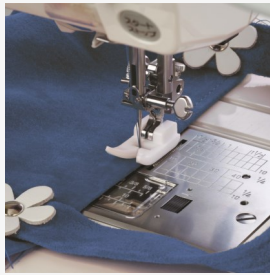

Ref.: 202-091-206



680/+, 710, 720PRO, 730/PRO, 760/PRO, 770, 780/+, 782, 790PRO, 792PRO, 850, 860, 900, 920

Pied zigzag variable à fourche ouverte (QZ)



Ref.: 862-895-006



770, 780/+, 920

Kit complet avec unité pour double transport



Ref.: 202-234-007



680/+, 850, 860

Kit complet de pieds pour le quilting en piqué libre

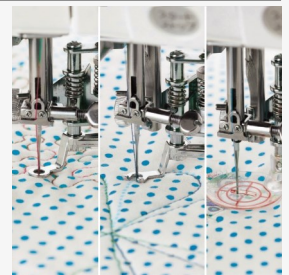

Ref.: 202-243-009



680/+, 720PRO, 730/PRO, 760/PRO, 850, 860

Kit de pieds pour le quilting en piqué libre

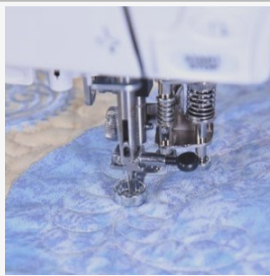

Ref.: 767-434-016



680/+, 720PRO, 730/PRO, 760/PRO, 850, 860 - Qu'en utilisant le support 858-820-018

Pied transparent de quilting avec guides (OV)

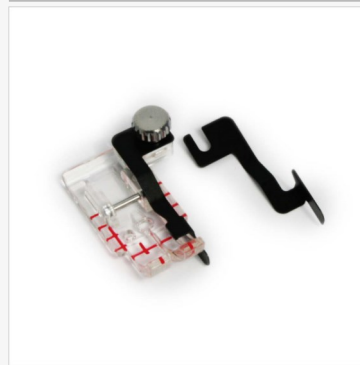

Ref.: 202-089-201



680/+, 710, 720PRO, 730/PRO, 760/PRO, 770, 780/+, 782, 790PRO, 792PRO, 850, 860, 900, 920

Pied ultra glisse anti-adhérent et plaque
aiguille anti-adhérente



Ref.: 202-237-000



680/+, 710, 720PRO, 730/PRO, 760/PRO, 770, 780/+, 782, 850, 860, 900, 920

Pied ultra glisse anti-adhérent et plaque
aiguille anti-adhérente



Ref.: 202-497-000



790PRO, 792PRO

Guide de couture sur rubans - large

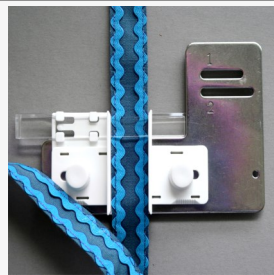

Ref.: 200-444-419



680/+, 710, 720PRO, 730/PRO, 760/PRO, 770, 780/+, 782, 790PRO, 792PRO, 850, 860, 920

Guide de matelassage



Ref.: 755-802-001



680/+, 720PRO, 770, 780/+, 850, 860, 920

Guide étroit pour nervures renforcées par
la pose de cordonnets



Ref.: 503-810-005



900

Guide large pour nervures renforcées par
la pose de cordonnets



Ref.: 503-809-001



900

Guide tissu



Ref.: 858-401-008



770

Guide tissu T



Ref.: 200-100-100



680/+, 720PRO, 770, 780/+, 782, 792PRO, 850, 860, 920

Dispositif et pied pour pose de biais (W1)

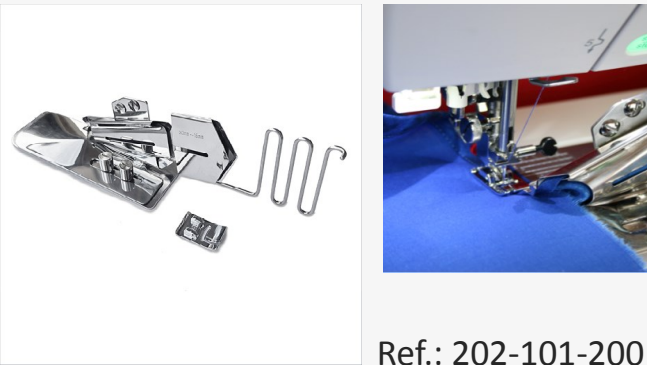

Ref.: 202-101-200



900

Dispositif et pied pour pose de biais (W1)

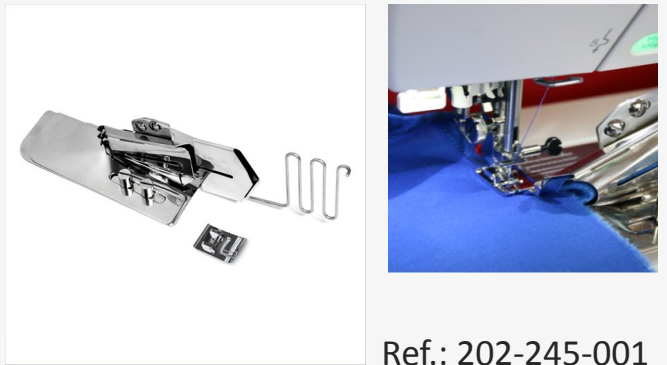

Ref.: 202-245-001



680/+, 710, 720PRO, 730/PRO, 760/PRO, 770, 780/+, 782, 790PRO, 792PRO, 850, 860, 920

Guide de matelassage et guide pour couture centrale



Ref.: 202-249-005



680/+, 850, 860

Guides pour nervures renforcées par la pose de cordonnets - large et étroit



Ref.: 202-238-001



680/+, 710, 720PRO, 730/PRO, 760/PRO, 770, 780/+, 782, 790PRO, 792PRO, 850, 860, 920

Longs guides de matelassage

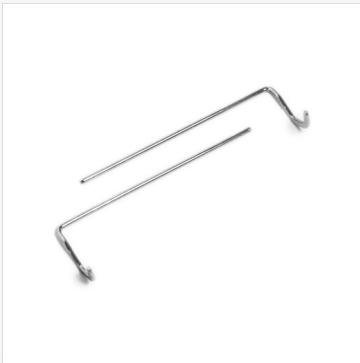

Ref.: 202-025-405



680/+, 710, 720PRO, 730/PRO, 760/PRO, 770, 780/+, 790PRO, 792PRO, 850, 860, 900, 920

Plaque aiguille pour couture droite

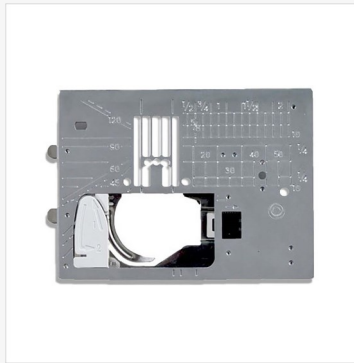

Ref.: 861-801-013



850, 860

Plaque aiguille professionnelle HP

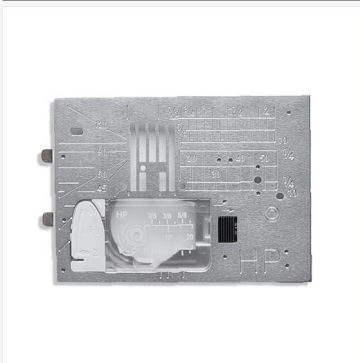

Ref.: 865-805-019



770

Capsule spéciale pour quilting en piqué libre

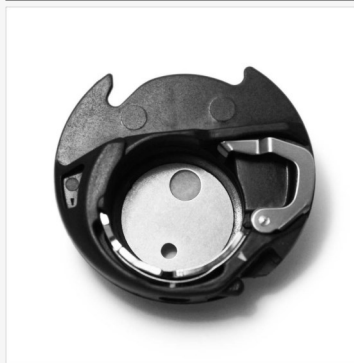

Ref.: 200-445-029



680/+, 720PRO, 730/PRO, 760/PRO, 770, 780/+, 782, 850, 860, 900, 920

Guide pour couture circulaire

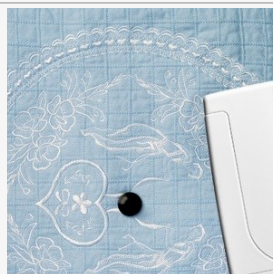

Ref.: 202-242-008



680/+, 710, 720PRO, 730/PRO, 760/PRO, 770, 780/+, 782, 790PRO, 792PRO, 850, 860, 900, 920

Kit pour fonctionnalités avancées pour eXcellence 770 et 780 contenant: Mise-à-jour logiciel et 4 pieds-de-biche

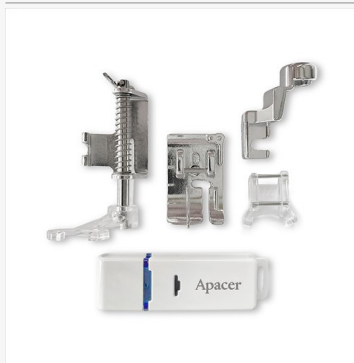

Ref.: 865-403-002



770, 780

Couture, Patchwork et Quilting 9mm

Logiciel Stitch Composer



Ref.: 861-827-004



770

Loupe optique ajustable (1.2x)



Ref.: 202-399-001



680/+, 720PRO, 730PRO, 760PRO, 770, 780/+, 782, 792PRO, 850, 860, 920

Set de trois loupes optiques 1.2x, 1.4x et 1.6x.



Ref.: 202-157-005



680/+, 710, 730/PRO, 760/PRO, 770, 780/+, 782, 850, 860, 900, 920

Set de trois loupes optiques 1.2x, 1.4x et 1.6x.



Ref.: 202-496-009



790PRO, 792PRO





ACCESSOIRES POUR LA BRODERIE

Pour les machines à coudre et à broder combinées et pour les brodeuses

Nos modèles de machines à coudre et à broder combinées et de brodeuses valorisent au plus près de leurs capacités les possibilités de cette discipline qu'est la broderie. Une même création peut se métamorphoser grâce à des motifs de broderie qui vont entièrement personnaliser vos projets de confection et de décoration, ainsi que vos accessoires.

Tous les motifs de broderie inclus sont minutieusement étudiés pour obtenir des résultats irréprochables et une régularité à toute épreuve. Nos accessoires de broderie vont vous permettre d'élargir vos possibilités grâce à des cerceaux en option, mais également d'aménager votre environnement de travail pour vous simplifier la tâche!



Les modèles de brodeuses concernés par cette catégorie sont:

eXpressive 820 (elna 8200 et 8300)
eXpressive 830 et 830L
eXpressive 850 et 860
eXpressive 900
eXpressive 920
eXpressive 940 (elna 9900)
eXpressive 970

N.B. : les anciens modèles correspondants aux modèles de la gamme actuelle sont indiqués entre parenthèses.

Canette large



Ref. : 770-591-001



970

Cônes guide-fil



Ref. : 862-410-508



Guide additionnel pour dispositif pour broderie à fil couché 202-394-006

Dispositif pour broderie à fil couché



Ref. : 202-394-006



830/L, 920

Cerceau casquette rectangulaire 100 x 90 mm



Ref. : 200-335-003



820, 830/L

Cerceau pour broderie sur casquette



Ref. : 770-489-005



940, 970

Cerceau pour broderie sur casquette 100 x 90 mm



Ref. : 859-436-005



900, 920

Adaptateur pour cerceaux Monogrammes J1 à J8



Ref. : 770-482-008

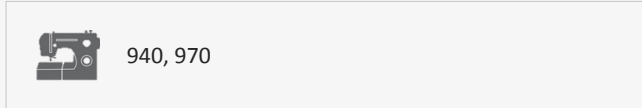

Cerceau pour monogramme - J1 n°11 - 30 mm diamètre



Ref. : 770-487-704

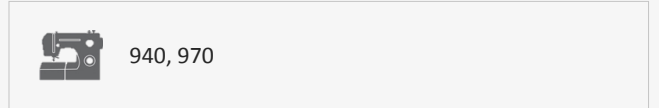

Cerceau pour monogramme - J1 n°12 - 30 mm diamètre



Ref. : 770-487-807

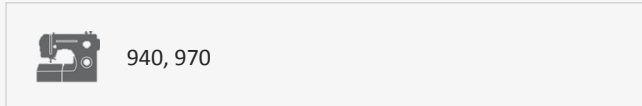

Cerceau pour monogramme - J2 n°6 - 25 x 54 mm



Ref. : 770-487-302

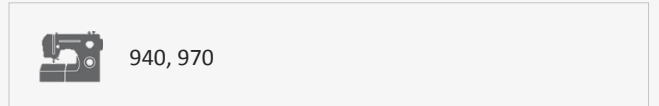

Broderie

Cerceau pour monogramme - J3 n°13 - 64 x 28 mm



Ref. : 770-487-900

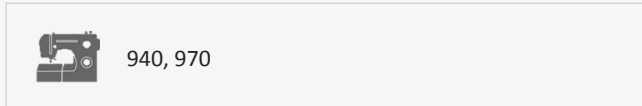

Cerceau pour monogramme - J4 n°8 - 42 x 67 mm



Ref. : 770-487-508

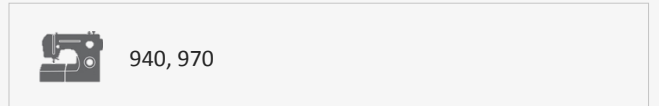

Cerceau pour monogramme - J5 n°3 - 46 x 46 mm

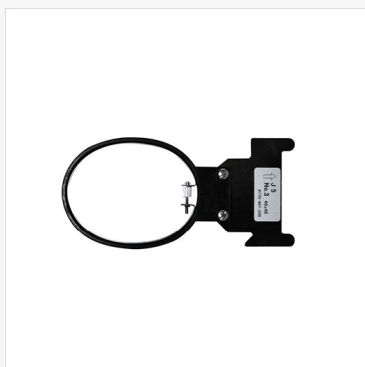

Ref. : 770-487-209

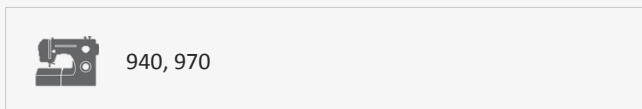

Cerceau pour monogramme - J6 n°2 - 66 x 66 mm



Ref. : 770-487-106

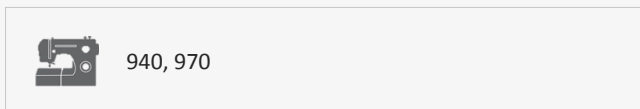

Cerceau pour monogramme - J6 n°9 - 66 x 66 mm



Ref. : 770-487-601

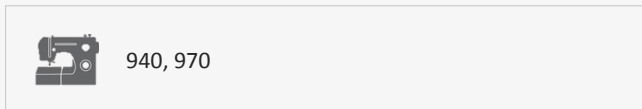

Cerceau pour monogramme - J7 n°1 - 110 x 95 mm



Ref. : 770-487-003

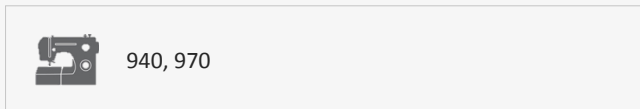

Cerceau pour monogramme - J8 n°7- 120 x 121 mm



Ref. : 770-487-405

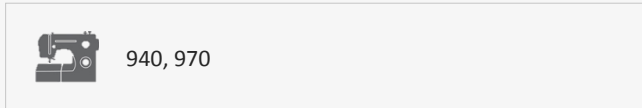

Kit de cerceaux pour broderie sur chaussettes



Ref. : 770-480-006

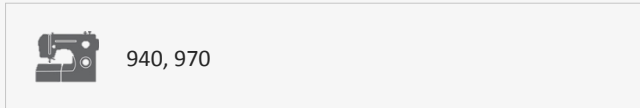

Cerceau bras libre - FA10a - 100 x 40 mm



Ref. : 861-407-004



850, 860

Cerceau grand rectangle - RE28b - 200 x 280 mm



Ref. : 864-411-000



830/L

Cerceau min rectangle - RE10b - 100 x 40 mm



Ref. : 864-415-004



830/L

Cerceau petit rectangle - RE20b - 140 x 200 mm



Ref. : 864-413-002



830/L

Cerceau rectangle - RE18 - 140 x 180 mm



Ref. : 859-451-006



900, 920

Cerceau rectangulaire grand – M1 – 240 x 200 mm



Ref. : 770-807-003



940, 970

Cerceau rectangulaire moyen – M2 – 126 x 100 mm

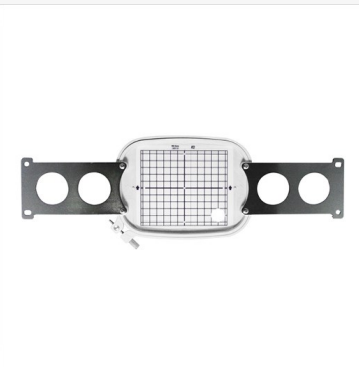

Ref. : 770-808-004

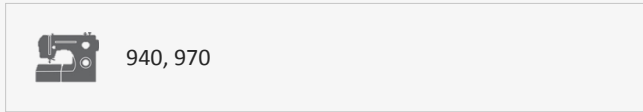

Kit de quilting avec cerceau carré - ASQ22 - 220 x 220 mm



Ref. : 862-413-006

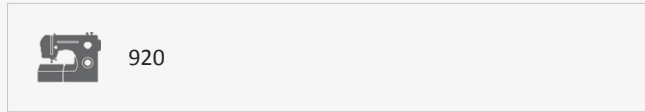

Kit de quilting avec cerceau carré grand - SQ20b - 200 x 200 mm



Ref. : 864-412-001

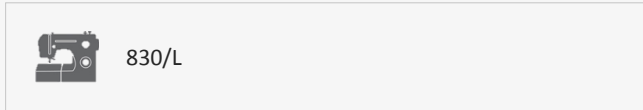

Kit de quilting avec cerceau carré petit - SQ14b - 140 x 140 mm



Ref. : 864-414-003

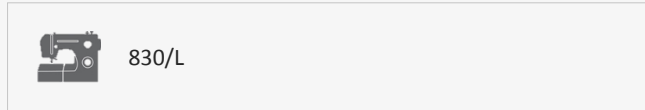

Kit de quilting avec cerceau carré-ASQ18b - 184 x 184 mm



Ref. : 864-410-009

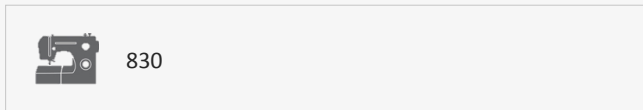

Kit de quilting avec cerceau carré-ASQ18b - V2.3 mise à jour



Ref. : 864-436-001

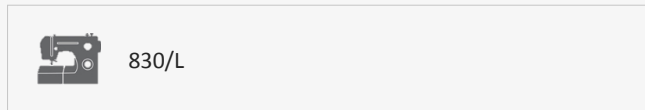

Broderie

Petit cerceau – M3 – 50 x 50 mm



Ref. : 770-809-005



940, 970

Capsule spéciale pour broderie

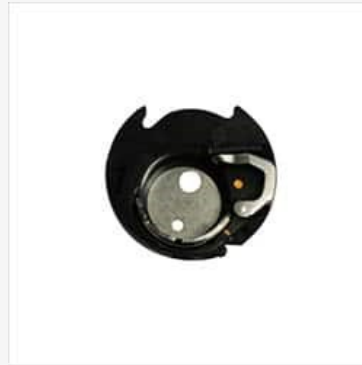

Ref. : 202-253-002



830/L, 850, 860, 900, 920

Collection de grands motifs de broderie



Ref. : 202-296-007



900, 830/L, 920

Kit pour broderie à fil couché et sa brosse métallique

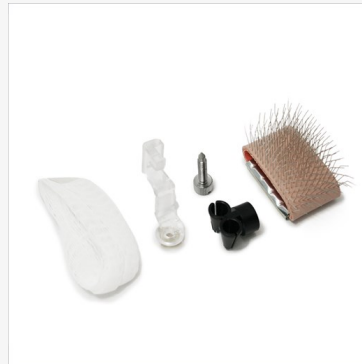

Ref. : 200-383-028



830/L, 850, 860, 920



Lecteur CD-Rom et DVD



Ref. : 860-429-009



820, 970

Positionneur 1



Ref. : 859-442-200



830/L, 850, 860, 900, 920

Ruban antidérapant pour cerceau de broderie

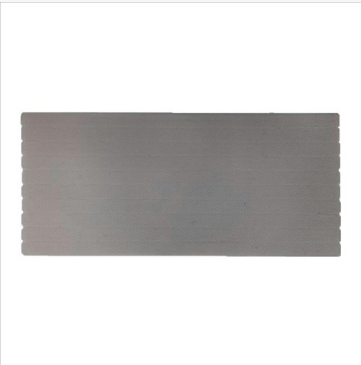

Ref. : 864-813-006



830/L, 920





ACCESSOIRES OPTIONNELS

Surjeteuses et recouvreuses

Pour les amateurs de finitions solides et soignées, les surjeteuses et recouvreuses sont indispensables. En effet, ces dernières vous offrent non seulement des finitions parfaites, mais également la possibilité de travailler des matières stretch beaucoup plus facilement qu'avec une machine à coudre classique. La vaste collection d'accessoires en option pour nos surjeteuses et recouvreuses va vous permettre de découvrir toutes les possibilités qu'offrent ces machines à coudre parfois méconnues. Les ourlets, les fronces et la pose de biais n'auront plus de secrets pour vous!



Les modèles de surjeteuses et recouvreuses concernés par cette catégorie sont:

eXtend 264
eXtend 664 et 664PRO
eXtend 745 et 845
eXtend 864*air*
eXtend *easycover*
eXtend *covermax* (elna 434 et 444)

N.B. : les anciens modèles correspondants aux modèles de la gamme actuelle sont indiqués entre parenthèses.

Pied à froncer



Ref. :200-248-008



264, 664/PRO, 864air

Pied à froncer avec guide

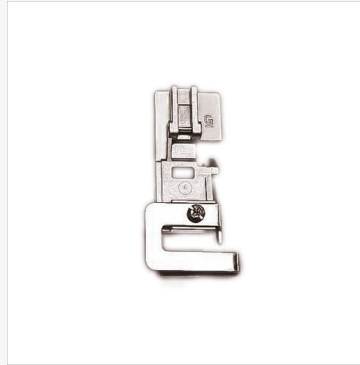

Ref. :200-807-001



745, 845

Pied ajustable pour pose de biais (M)



Ref. :200-810-007



745, 845

Pied avec guide de couture central



Ref. :795-819-119



easycover, covermax

Pied d'attache en métal (inclus dans les kits 795-838-114 et 795-844-032)



Ref. :795-825-004



easycover, covermax

Pied d'attache transparent avec guide (ce pied est inclus dans les sets n. 202-403-009 et 202-404-000)



Ref. :796-402-004



easycover, covermax

Pied multi-usages



Ref. :200-805-009

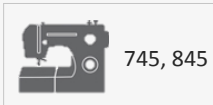

Pied ourlet couvert supérieur (R)



Ref. :797-812-004

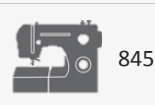

Pied passepoil pour pose de mèches ou cordonnet (E)



Ref. :200-814-104

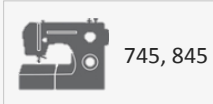

Pied pour création de brides



Ref. :200-808-002

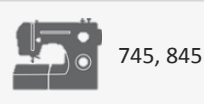

Pied pour nervures ou pose de cordonnets (K)



Ref. :200-802-202

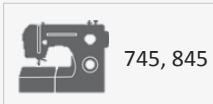

Pied pour ourlet couvert (M)



Ref. :200-801-304

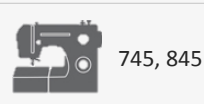

Pied pour ourlet invisible (D)



Ref. :202-040-015



264, 664/PRO, 864air

Pied pour ourlet invisible (D)



Ref. :202-255-004



745, 845

Pied pour pose de cordonnets de type A



Ref. :202-034-016



264, 664/PRO, 864air

Pied pour pose de cordonnets de type B

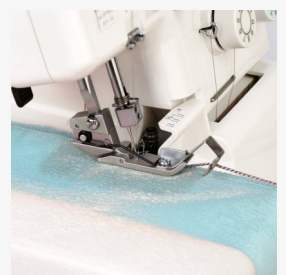
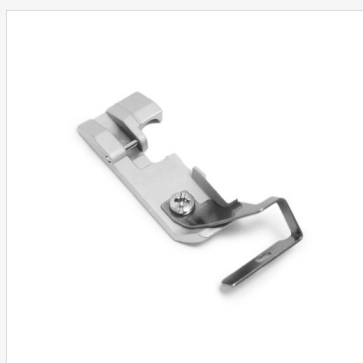

Ref. :202-035-017



264, 664/PRO, 864air

Pied pour pose de perles (Incl. guide)

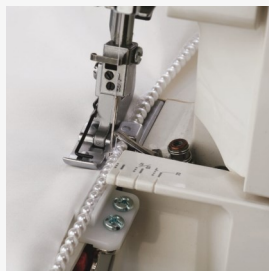

Ref. :202-041-119



264, 664/PRO

Pied pour pose de rubans (Q)

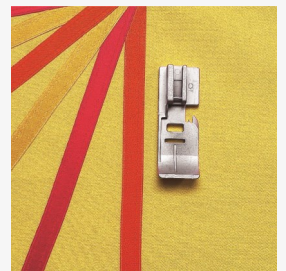
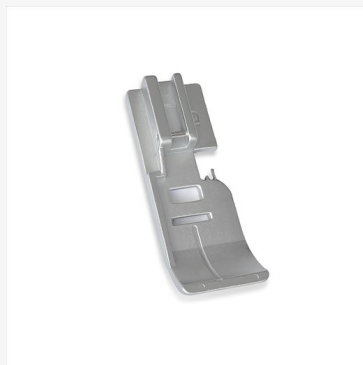

Ref. :496-245-20



745, 845

Pied transparent pour ourlet couvert



Ref. :795-818-118

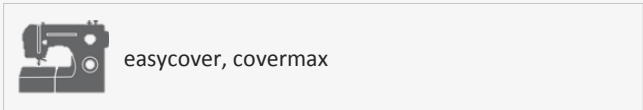

Pied transparent pour point chaînette (F)



Ref. :200-803-306

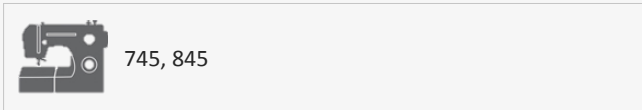

Pied transparent pour point chaînette avec 2 guides



Ref. :202-247-003

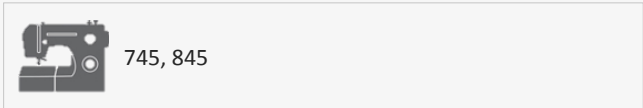

Pied transparent pour pose de perles



Ref. :200-809-003

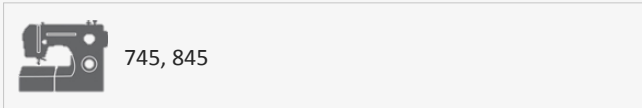

Pied transparent pour surpiqûre de couture ouverte (N)



Ref. :200-804-101

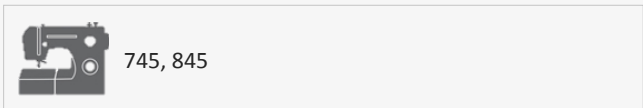

Pieds passepoil à 1/8 et 3/16 de pouce



Ref. :202-039-011

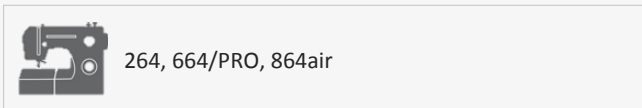

Surjeteuses et recouvreuses

Kit contenant le pied multi-usages et 3 guides fonceur pour élastiques



Ref. :202-248-004

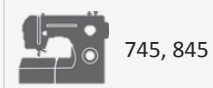

Pied pour ourlet couvert avec guides : H-1, H-2 et H-3



Ref. :202-254-003

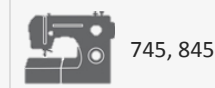

Guide de couture ajustable

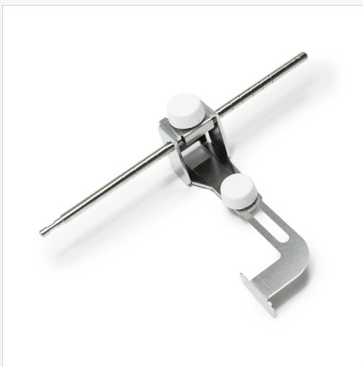

Ref. :795-806-113

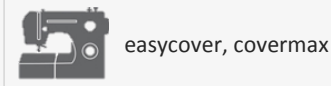

Guide de matelassage



Ref. :797-881-004



Guide en métal pour pied à froncer



Ref. :202-036-111

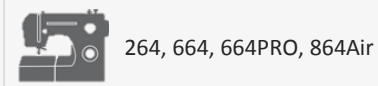

Guide fil additionnelle



Ref. :200-811-008

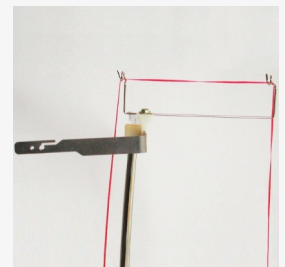

Guide pour biais et plieuse pour pose de ceinture

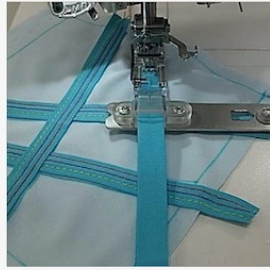

Ref. :202-464-101



easycover, covermax

Guide pour cordonnet



Ref. :200-802-305



745, 845

Guide pour couture ouverte (N-1)



Ref. :200-804-008



745, 845

Guide pour couture rabattue (F-4)



Ref. :200-803-203



745, 845

Guide pour coutures courbés



Ref. :200-812-009



745, 845

Guide pour dentelle ou bordure (F-3)



Ref. :200-803-100



745, 845

Guide pour pose de biais étroit et pied d'attache en métal (pied disponible séparément art. 795-825-004)



Ref. :795-838-114



easycover, covermax

Guide pour pose de biais large et pied d'attache en métal (pied disponible séparément art. 795-825-004)

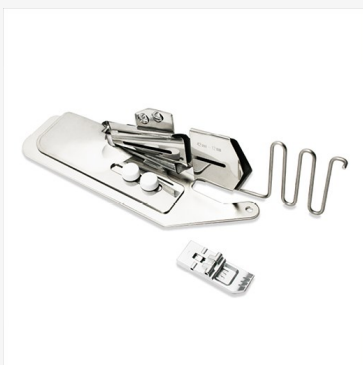

Ref. :795-844-032



easycover, covermax

Guide pour pose de dentelle en bordure (H-1)



Ref. :200-801-005



745, 845

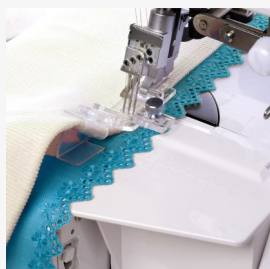

Guide pour pose de biais étroit et pied d'attache transparent (8mm) (pied disponible séparément art. 796-402-004)



Ref. :202-403-009



easycover

Guide pour pose de biais large et pied d'attache transparent (12mm) (pied disponible séparément art. 796-402-004)



Ref. :202-404-000



easycover

Guide supérieur rond pour ourlet couvert supérieur



Ref. :797-343-009



845

Guide tissu



Ref. :202-038-010



264, 664/PRO, 864air

Guide tissu gradué



Ref. :396-001-42



745, 845

Crochet pour ourlet couvert supérieur



Ref. :797-342-008



845

Fronceur élastique



Ref. :202-037-019



264, 664/PRO, 864air

Fronceur élastique - étroit



Ref. :795-816-116



easycover, covermax

Fronceur élastique - large

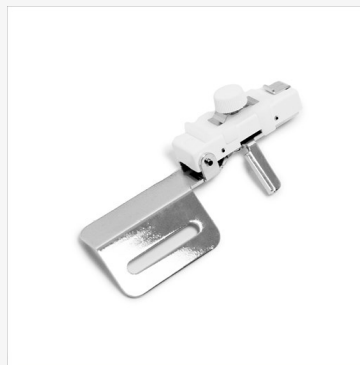

Ref. :795-817-117



easycover, covermax

Guide fronceur pour élastique
10 mm de largeur

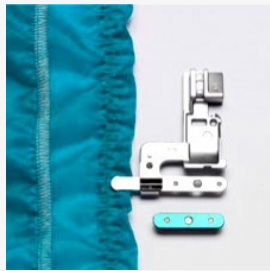

Ref. :200-805-205

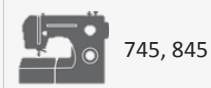

Guide fronceur pour élastique
13 mm de largeur

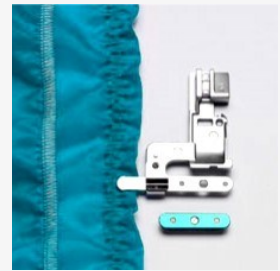

Ref. :200-805-308

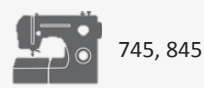

Guide fronceur pour élastique
7.5 mm de largeur

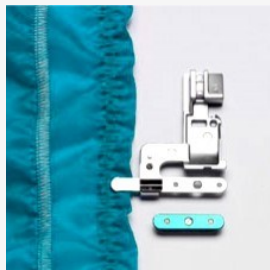

Ref. :200-805-102

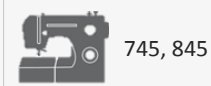

Récipient pour chutes de tissus et déchets



Ref. :202-460-004



Récipient pour chutes de tissus et déchets



Ref. :797-866-106



Récipient pour chutes de tissus et déchets
(design 2022)



Ref. :798-042-A01



Surjeteuses et recouvreuses

Set pour pose de rubans



Ref. :202-033-015



264, 664/PRO

Support de base pour accessoires

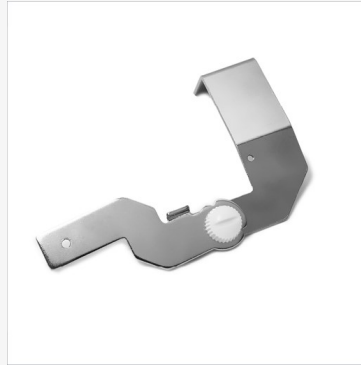

Ref. :200-812-102



745, 845

elna
SWISS DESIGN





ACCESSOIRES ET ARTICLES GÉNÉRAUX

Cette catégorie regroupe tous les articles qui vous seront indispensables pour une utilisation optimale de votre machine à coudre elna.

Des canettes aux tables de couture, en passant par les sacs de transport, ces accessoires vous permettront d'améliorer votre environnement de travail et surtout, de vous faciliter la tâche!



Cette catégorie concerne tous les modèles de machines à coudre, de brodeuses, de surjeteuses et de recouvreuses elna.

Sac de transport à roulettes elna
L 56cm x H 45cm x P 34cm



Ref. :395-800-01



Lotus/2, 450, 520/S, 540/S, 530, 550, 560, 570/α,
580/+, 680/+, 720PRO, 770, 780/+, 782, 792PRO,
850, 860, 264, 664/PRO, 864air, easycover,

Sac pour surjeteuse elna
34 x 33 x 32 cm (LxHxP)



Ref. :395-800-02



264, 664/PRO, 864air, easycover, covermax

Sac pour accessoires elna
33 x 26 cm (LxH)



Ref. :395-800-03



Universel



Pochette additionnelle pour sac
accessoires elna



Ref. :395-800-04



Pochette additionnelle pour sac accessoires 395-800-03

Coffret de rangement - grand modèle



Ref. :866-801-018



Universel

Coffret de rangement - petit modèle



Ref. :843-823-004



Universel

Coque de protection



Ref. :404-701-404



530, 550, 560, 570/α,

Housse de protection semi-rigide
415 x 320 x 280 mm (LxHxP)



Ref. :849-804-007



520/S, 540/S

Housse de protection semi-rigide
480 x 340 x 250 mm (LxHxP)



Ref. :846-831-004



720

Housse de protection semi-rigide
520 x 340 x 360 mm (LxHxP)



Ref. :861-806-100



580/+, 680/+ 850, 860

Housse de protection semi-rigide
540 x 340 x 260 mm (LxHxP)



Ref. :858-802-069



720PRO, 730/PRO, 760/PRO, 770, 780/+, 782, 792PRO

Sac de transport elna



Ref. :849-802-005



Sew, 150, 160, 220, 240, 320, 340, 3210j, Star, Lotus/2, 450, 520/S, 540/S, 530, 550, 560, 570/α, covermax, easycover

Sac de transport et housse de protection
42 x 29 x 18 cm (LxHxP)



Ref. :395-800-15



Sew, 150, 160, 220, 240, 320, 340, 3210j, Star, 450, 520/S, 540/S, 530, 550, 560, 570/α

Capsule basse-tension pour quilting en piqué libre



Ref. :202-495-008



790PRO, 792PRO

Porte-canette métallique



Ref. :395-710-08



Sew, 220, 240

Porte-canette métallique



Ref. :770-590-000



970

Canette elna



Ref. :395-751-83



Universel

Canette elna "easy bobbin"



Ref. :202-192-404



Universel

Canettes elna "easy bobbin" (x10)



Ref. :202-260-002



Canettes elna (x10)



Ref. :200-122-027

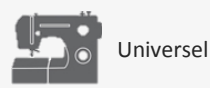

Clé USB



Ref. :395-741-60

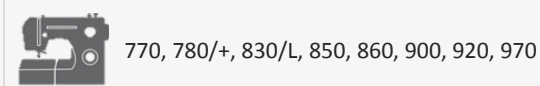

Porte-bobines - 2 bobines / cônes



Ref. :202-513-003



Dispositif pour pédale coupe-fil



Ref. :865-810-006

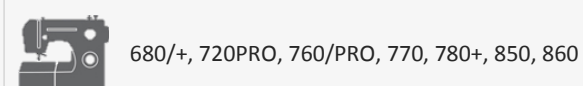

Kit avec pédale coupe-fil et pédale de contrôle large



Ref. :858-418-008

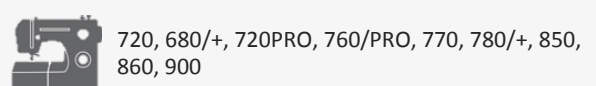

Pédale de contrôle - large



Ref. :858-417-007



Star, 450, 520/S, 540/S, 530, 550, 560, 570/α, Lotus/2, 580/+, 680/+, 710, 720PRO, 730/PRO, 760/PRO, 770, 780/+, 850, 860, 900

Protection Doigts

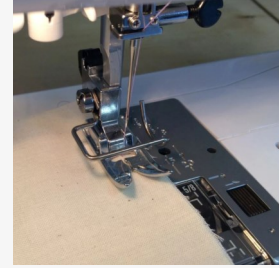

Ref. :687-803-008



Sew, 150, 160, 220, 240, 320, 340, 3210j, Star, Lotus/2, 450, 520/S, 540/S, 530, 550, 560, 570/α, 580/+, 680/+, 720PRO, 760/PRO, 770, 780/+, 782,

Fourche à tapis

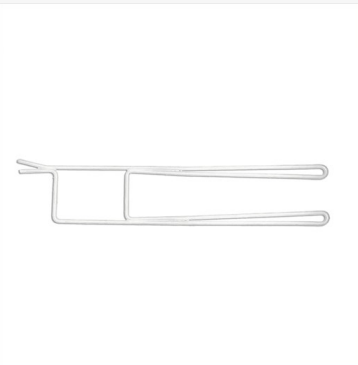

Ref. :424-630-10



Universel

Genouillère



Ref. :846-417-022



770

Point pivot pour couture circulaire



Ref. :849-801-004



220, 240, 620, 660, 580, 580+, 680/+, 730/PRO, 760/PRO, 770, 780, 780+, 850, 860, 920

Support de rubans (pour guide pour pose de biais)



Ref. :202-402-008



Lotus, Lotus/2, 580/+, 680/+, 720, 720PRO, 770, 780/+, 782, 792PRO, 850, 860, 920, easycover, covermax

Tapis elna



Ref. :301-804-004



Sew, 150, 160, 220, 240, 320, 340, 3210j, Star, Lotus/2, 450, 520/S, 540/S, 530, 550, 560, 570/α, 580/+, 680/+, 264, 664/PRO, 745, 845, 864air,

Disque fixe-bobine: grand modèle

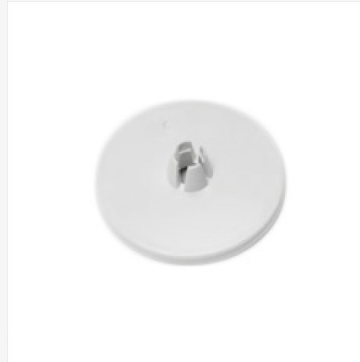

Ref. :822-020-503



150, 160, 320, 340, 3210j, Star, 450, 520/S, 540/S, 530, 550, 560, 570/α, 580/+, 680/+, 720PRO, 730/PRO, 760/PRO, 770, 780/+, 830/L, 850, 860, 900,

Disque fixe-bobine: modèle spécial



Ref. :202-240-006



150, 160, 320, 340, 3210j, Star, 450, 520/S, 540/S, 530, 550, 560, 570/α, 580/+, 680/+, 720PRO, 730/PRO, 760/PRO, 770, 780/+, 830/L, 850, 860, 900,

Disque fixe-bobine: petit modèle



Ref. :822-019-509



150, 160, 320, 340, 3210j, Star, 450, 520/S, 540/S, 530, 550, 560, 570/α, 580/+, 680/+, 720PRO, 730/PRO, 760/PRO, 770, 780/+, 830/L, 850, 860, 900,

Porte-bobines - 2 bobines / cônes



Ref. :859-449-012



580/+, 680/+, 730/PRO, 760/PRO, 770, 780/+, 782, 792PRO, 830/L, 850, 860, 900, 920

Porte-bobines - 5 bobines / cônes



Ref. :859-450-005



580/+, 680/+, 770, 780/+, 782, 792PRO, 830/L, 850, 860, 900, 920

Coussin à épingles - blanc



Ref. :202-256-016



150, 160, 320, 340, 3210j, 450, 520/S, 540/S, 530, 550, 560, 570/α, 580/+, 680/+, 770, 780/+, 782, 792PRO, 850, 860, 920

Coussin à épingles - jaune



Ref. :202-256-038



150, 160, 320, 340, 3210j, 450, 520/S, 540/S, 530, 550, 560, 570/α, 580/+, 680/+, 770, 780/+, 782, 792PRO, 850, 860, 920

Coussin à épingles - mauve



Ref. :202-256-027



150, 160, 320, 340, 3210j, 450, 520/S, 540/S, 530, 550, 560, 570/α, 580/+, 680/+, 770, 780/+, 782, 792PRO, 850, 860, 920

Coussin à épingles - rose



Ref. :202-256-005



150, 160, 320, 340, 3210j, 450, 520/S, 540/S, 530, 550, 560, 570/α, 580/+, 680/+, 770, 780/+, 782, 792PRO, 850, 860, 920

Général

Broche porte-bobine supplémentaire



Ref. :395-710-23



Lotus/2

Kit table d'extension extra-large avec guide de couture (61cm x 40cm)



Ref. :858-419-010



710, 730/PRO, 760Pro

Table d'extension extra-large
(40cm x 28cm)



Ref. :811-806-002



530, 550, 560, 570/α

Table d'extension transparente extra-large



Ref. :865-812-008



770, 780/+

Table de couture avec tiroir et sans
plateau d'intégration



Ref. :494-719-002



790PRO, 792PRO

Table de couture sans plateau
d'intégration



Ref. :399-000-78



730/PRO, 740, 760/PRO

Général

Table d'extension



Ref. :489-709-508



720

Table d'extension (40cm x 28cm)



Ref. :502-403-008



450

Table d'extension (45cm x 24,5cm)



Ref. :491-701-138



520/S, 540/S

Table d'extension extra-large en plexiglas
50cm x 31cm



Ref. :861-406-025



580/+, 680/+ 850, 860

Table d'extension pour brodeuse (43cm x 38cm)



Ref. :770-814-003



940, 970

Table d'extension pour le quilting et la
couture



Ref. :506-803-004



3210j

Table d'extension pour recouvreuse
(29.5cm x 20.5cm)



Ref. :795-812-307



easycover, covermax

Pochettes de rangement pour table de
couture

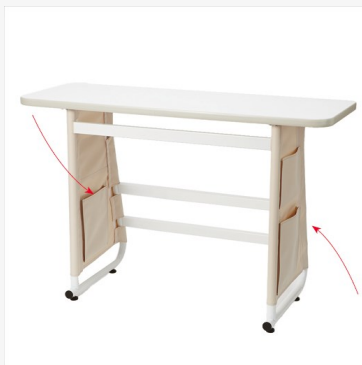

Ref. :494-805-006



Universel

Table de couture avec plateaux d'intégration A, B et C



Ref. :494-711-004



710, 720, 730PRO, 760PRO, 900

Table de couture sans plateaux d'intégration



Ref. :494-710-003



580/+, 680/+, 720, 720PRO, 730PRO, 760PRO, 770, 780/+, 782, 850, 860, 900, 920

Table de couture sans tiroir ni plateaux d'intégration



Ref. :494-708-101



580/+, 680/+, 710, 720, 720PRO, 730PRO, 760PRO, 770, 780/+, 782, 850, 860, 900, 920

Table de travail sans espace d'intégration 115 x 45 x 76 cm (LxPxH)



Ref. :494-709-009



Universel

Général

Tiroir optionnel pour table de couture 494-708-101



Ref. :494-708-204



580/+, 680/+, 720, 720PRO, 730PRO, 760PRO, 770, 780/+, 782, 850, 860, 900, 920

Plateau d'intégration A



Ref. :494-401-101



710, 730PRO, 760PRO, 900

Plateau d'intégration B



Ref. :494-402-102

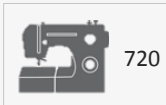

Plateau d'intégration D



Ref. :494-405-105

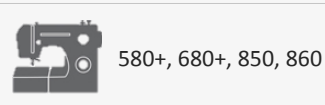

Plateau d'intégration E



Ref. :494-406-106

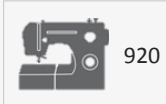

Plateau d'intégration G



Ref. :494-408-108

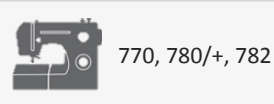

Général

Plateau d'intégration H



Ref. :494-712-005

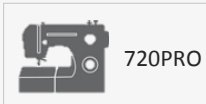

Plateau d'intégration K



Ref. :494-411-104

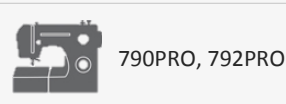

Burette d'huile



Ref. :741-814-003



Découd-vite



Ref. :200-133-021

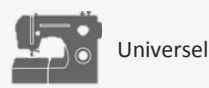

Enfile aiguille manuel



Ref. :200-347-020



Enfile boucleur inférieur



Ref. :784-806-005



Pince brucelles



Ref. :624-801-001



Pinceau de nettoyage



Ref. :802-424-004

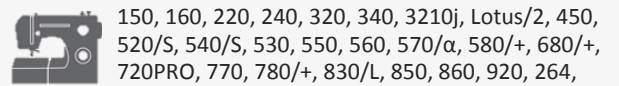

Tournevis - fin



Ref. :647-803-004

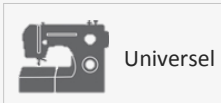

Tournevis - Petit



Ref. :820-832-005

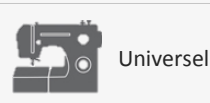

Kit d'aiguilles Cutwork: 0°, 45°, 90°, 135°



Ref. :202-298-009

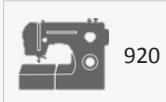

Set d'aiguilles à tête bleue: 75/11 - pour tissus synthétiques

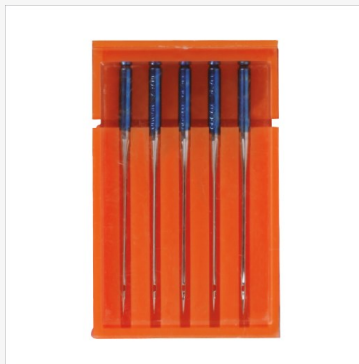

Ref. :200-346-029



Set d'aiguilles à tête rouge: Pour tissus moyen à épais - taille 90/14



Ref. :990-314-132

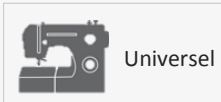

Set d'aiguilles à tête violette: pour tissu épais ou maille - taille 90/14



Ref. :202-244-000

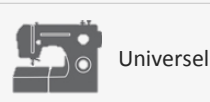

Set d'aiguilles jumelées universel: 1x
aiguille jumelée, 2x 75/11, 1x 90/14, 1x



Ref. :200-343-026



Universel

Set d'aiguilles universel: 2x 75/11, 1x
aiguille à tête bleue, 2x 90/14



Ref. :200-135-023



Universel



AIGUILLES STANDARD POUR REMPLACEMENT DE ROUTINE

AIGUILLES

Catégorie - Modèles - Références

5-7 mm	Sew, 159, 160, 220, 240, 450	639-804-000
5-7 mm	320, 340, 3210J, 530, 550, 560, 570a	540-401-026
5-7 mm	580+	820-827-007
9 mm	680+, 710, 720PRO, 730PRO, 770, 780+, 782, 790PRO, 792PRO, 850, 920	859-856-005
Embroidery	830, 830L	852-802-108
Overlock	264, 664, 664PRO, 864air, 845	784-860-100
Coverstitch	easycover, covermax	795-802-005

LES AIGUILLES

Chaque tissu mérite d'être travaillé avec une aiguille particulière.
Un bon nombre de difficultés rencontrées pendant la couture peuvent être évitées
avec une utilisation correcte des accessoires et surtout, le choix de la bonne aiguille!
Pour assurer une qualité sans faille, toutes nos aiguilles sont fabriquées par la maison Schmetz.

AIGUILLES UNIVERSELLES

Dénomination et type - Application - Référence

Système 130/705 H: Avec pointe légèrement arrondie qui évite les points sautés et les blocages pour une couture fluide sur de nombreuses matières.

Aiguilles H 60/8	Aiguilles universelles, 5 pièces, taille 60	424-830-10
Aiguilles H 70/10	Aiguilles universelles, 5 pièces, taille 70	424-840-10
Aiguilles H 80/12	Aiguilles universelles, 5 pièces, taille 80	424-850-10
Aiguilles H 90/14	Aiguilles universelles, 5 pièces, taille 90	424-860-10
Aiguilles H 100/16	Aiguilles universelles, 5 pièces, taille 100	424-870-10
Aiguilles H 110/18	Aiguilles universelles, 5 pièces, taille 110	424-880-10
Aiguilles H 120/19	Aiguilles universelles, 5 pièces, taille 120	424-890-10
Aiguilles H 70/80/90	Set d'aiguilles universelles: 2x70 / 2x80 / 1x90	424-451-20

Aiguilles universelles jumelées et triples.

Aiguilles H-ZWI 70/1,6	2 Aiguilles jumelées 1,6 mm Universelle, taille 70	427-185-20
Aiguille H-ZWI 80/2,0	Aiguille jumelée 2 mm Universelle, 1 pce, taille 80	427-630-10
Aiguille H-ZWI 80/4,0	Aiguille jumelée 4 mm Universelle, 1 pce, taille 80	427-610-10
Aiguille H-ZWI BR 100/6,0	Aiguille jumelée 6 mm Universelle, 1 pce, taille 100	427-611-10
Aiguille H-DRI 80/2,5	Aiguille triple 2,5 mm Universelle, 1 pce, taille 80	427-045-20
Aiguille H-DRI 80/3,0	Aiguille triple 3 mm Universelle, 1 pce, taille 80	427-046-20
Aiguilles H-ZWI 80/2,0-2,5-4	Set d'aiguilles jumelées: 1x80/2 1x80/2,5 1x80/4	427-680-20

CUIR

Système 130/705 H LL: Avec pointe tranchante pour faciliter la perforation. Pour le cuir, le similicuir ou les matières similaires.

Aiguilles H-LL 80/12	Aiguilles pour le cuir, 5 pièces, taille 80	424-495-20
Aiguilles H-LL 90/14	Aiguilles pour le cuir, 5 pièces, taille 90	424-490-20
Aiguilles H-LL 100/16	Aiguilles pour le cuir, 5 pièces, taille 100	424-491-20
Aiguilles H-LL 110/18	Aiguilles pour le cuir, 5 pièces, taille 110	424-492-20

SURJETEUSES / RECOUVREUSES

Système ELx705: Pointe renforcée et chas plus long pour permettre les points chaînettes des surjeteuses et recouvreuses.

Aiguilles ELx705 80/12	Aiguilles pour surjeteuse, 5 pièces, taille 80	396-013-92
Aiguilles ELx705 90/14	Aiguilles pour surjeteuse, 5 pièces, taille 90	396-013-93
Aiguilles ELx705 80/90	Set d'aiguilles pour surjeteuse: 2x80 / 3x90	396-002-27

JEANS ET DENIM

Système 130/705 H-J: La pointe à bille moyenne pique plus facilement les tissus épais et serrés sans les léser. La tige renforcée dévie moins et réduit le risque de points sautés ou d'aiguille cassée.

Aiguilles H-J 70/10	Aiguilles pour le Jeans, 5 pièces, taille 70	424-265-20
Aiguilles H-J 90/14	Aiguilles pour le Jeans, 5 pièces, taille 90	424-260-20
Aiguilles H-J 100/16	Aiguilles pour le Jeans, 5 pièces, taille 100	424-261-20
Aiguille H-J ZWI 100/4,0	Aiguille jumelée 4mm pour Jeans, 1 pce taille 100	427-615-20

STRETCH

Dénomination et type - Application - Référence

Système 130/705 H-S: Avec pointe à bille moyenne. Sa forme évite les points sautés dans les matières élastiques, les tricots et la maille.

Aiguilles H-S 75/11	Aiguilles pour tissus stretch, 5 pièces, taille 75	424-245-20
Aiguilles H-S 90/14	Aiguilles pour tissus stretch, 5 pièces, taille 90	424-240-20
Aiguille H-S ZWI 75/2,5	1 aiguille jumelée 2,5 mm pour stretch, taille 75	427-176-20
Aiguille H-S ZWI 75/2,5	2 aiguilles jumelées 2,5 mm pour Stretch, taille 75	427-175-20
Aiguilles H-S ZWI 75/4,0	2 aiguilles jumelées 4 mm pour Stretch, taille 75	424-246-20

JERSEY / TRICOT

Système 130/705 H SUK: Avec pointe à bille moyenne. Idéales pour les tricots et la maille.

Aiguilles H-SUK 70/10	Aiguilles pour la maille, 5 pièces, taille 70	424-845-10
Aiguilles H-SUK 90/14	Aiguilles pour la maille, 5 pièces, taille 90	424-865-10
Aiguilles H-SUK 70/80/90	Set d'aiguilles pour la maille: 2x70 / 2x80 / 1x90	427-155-20

MICROTEX

Système 130/705 H-M: Avec pointe fine et pointue pour perforer les tissus très fins ou très denses.
Convient pour soie, microfibre, matières enduites et similicuir.

Aiguilles H-M 70/10	Aiguilles Microtex, 5 pièces, taille 70	424-841-10
Aiguilles H-M 80/12	Aiguilles Microtex, 5 pièces, taille 80	424-851-10
Aiguilles H-M 60/70/80	Set d'aiguilles Microtex: 2x60 / 2x70 / 1x80	424-452-20

OURLET À JOUR

Système 130/705 H WING: Contient une tige avec une ailette sur le côté pour repousser le tissu et former un espace.
Pour coutures fantaisies et ajourés dans des tissages légers.

Aiguille WING 100/16	Aiguille à ailette, 1 pièce, taille 100	427-240-20
Aiguille WING 120/19	Aiguille à ailette, 1 pièce, taille 120	427-245-20
Aiguilles ZWIHO 100	Aiguille jumelée 3 mm, 1 pièce, taille 100	427-042-20
Aiguilles ZWIHO	Aiguilles jumelées 3 mm, 2 pièces, taille 100	427-041-20
Aiguilles ZWIHO	Aiguilles jumelées 3 mm, 3 pièces, taille 100	427-040-20

QUILTING

Système 130/705 H-Q: Avec pointe arrondie et fine pour perforer les couches épaisses de tissu sans léser la matière.

Aiguilles H-Q 75/90	Set d'aiguilles pour quilting: 3x75 / 2x90	424-455-20
---------------------	--	------------

BRODERIE

Système 130/705 H-E: Avec une petite pointe à bille et un chas plus large pour les fils plus gros et les fils de broderie.

Aiguilles H-E 75/90	Set d'aiguilles à broder: 3x75 / 2x90	424-456-20
---------------------	---------------------------------------	------------

FIL MÉTALLIQUE

Système 130 MET: Avec un chas plus long pour les fils décoratifs ou les fils spéciaux. Idéale pour les fils métalliques.

Aiguilles H-M 90/14	Aiguille pour fil métallique, 5 pièces, taille 90	424-861-10
---------------------	---	------------





crafted with love

Elna International Corp. SA, Genève, Suisse

Sous réserve de modification sans préavis

© 2023

elna.com